

LEADING THE ENERGY TRANSITION

FACTBOOK

Concentrating Solar Power

SBC Energy Institute

June 2013



Compiled by the SBC Energy Institute

About SBC Energy Institute

The SBC Energy Institute, a non-profit organization founded in 2011 at the initiative of Schlumberger Business Consulting (SBC), is a center of excellence for scientific and technological research into issues pertaining to the energy industry in the 21st century. Through its unique capability to leverage both Schlumberger's technological expertise and SBC's global network of energy leaders, the SBC Energy Institute is at the forefront of the search for solutions to today's energy supply challenges. It is overseen by a scientific committee comprised of highly experienced individuals in the areas of natural and applied sciences, business, and petroleum engineering.

About *Leading the Energy Transition* series

"Leading the energy transition" is a series of publicly available studies on low-carbon energy technologies conducted by the SBC Energy Institute that aim to provide a comprehensive overview of their development status through a technological and scientific prism.

About the Concentrating Solar Power factbook

This factbook seeks to capture the current status and future developments of Concentrating Solar Power, detail the main technological hurdles and the areas for Research and Development, and finally analyze the economics of this technology.

This factbook has been reviewed by Prof. Dr.-Ing. Robert Pitz-Paal, Co-Director of the Institute of Solar Research from the German Aerospace Center (DLR) and his team.

For further information about SBC Energy Institute and to download the report, please visit <http://www.sbc.slb.com/sbcinstitute.aspx>, or contact us at sbcenergyinstitute@slb.com

| Concentrating Solar Power generates electricity by exploiting the direct-beam solar radiation

Solar energy is one of the most abundant resources in the world. Solar rays can be categorized in terms of the wavelengths that determine visible light, infrared and ultraviolet. The energy available from sunlight is measured in kilowatt hours per square meter. Generally, this source of energy is deemed good to excellent between 10° and 40°, South or North.

Concentrating Solar Power (CSP) is one of the four main solar-energy technologies, the others being solar photovoltaic, solar thermal and solar fuels. CSP depends on direct-beam irradiation and its maximum benefits are restricted to arid & semi-arid areas with clear skies, the most promising being the Middle East and North Africa, Australia, South Africa, as well as relevant areas in the US, Chile, Spain, India and Gobi Desert.

CSP plants use curved mirrors for concentrating solar radiation onto a dark receiver to heat up a fluid, which drives a turbine, converting heat into mechanical energy and then into electricity. It is classified by the technology used to focus the sun's ray. While four technologies exist, two dominate the market: parabolic trough & solar tower. CSP is also characterized by its storage ability. Thermal storage is relatively easy to integrate into CSP projects, and allows CSP plants to smooth variability, to firm capacity and to take advantage of peak power prices. CSP electricity generation is similar for the power block to conventional thermal generation, making CSP well fitted for hybridization with complementary solar field and fossil fuel as primary energy source. On top of conventional power generation, CSP can be applied in industrial processes to desalinate water, improve water electrolysis for hydrogen production, generate heat for Combined Heat & Power applications, and support enhanced oil recovery (EOR) operations.

| CSP capacity is not increasing fast enough compared to expected development

CSP installed capacity was just 2.8 GW at the end of 2012, even though the first commercial plant started operating in 1986 and despite a wave of construction in Spain during the mid-2000s and in the US and North Africa as part of EOR programs.

Plans for several CSP projects have been cancelled because of the economic crisis or converted to solar photovoltaic, a technology that benefits from reductions in the Solar Photovoltaic module price. CSP capacity is nonetheless expected to reach almost 11 GW by 2017, with the US, India, China and Middle East & North Africa (MENA) countries overtaking Spain as market leaders. Most CSP projects are still based on parabolic trough concentrators, despite the growing share of solar towers.

In the long run, the International Energy Agency (IEA) estimates that CSP would need to meet 8%-10% of global electricity demand by 2050 in order to contribute to a decarbonized energy system likely to limit the average global temperature increase to 2°C. For CSP to meet 8% of electricity demand, significant deployment outside the OECD and China would be required. To that end, the Desertec Industrial Initiative is promoting the installation of CSP plants in the sun-rich MENA deserts, with the aim of CSP's contribution to European electricity supply reaching up to 16% by 2050. However, this 400 USD billion energy plan has sometimes been criticized on its economics and local fall-throughs.

| RD&D is focused on improving thermal efficiency and on leveraging the competitive edge given to CSP by its ability to store heat

RD&D is focused on optimizing the thermal energy conversion cycle and thermal storage. Innovations are expected in all four technologies and throughout the system value chain. The main objectives are: to increase efficiency by using advanced optical components and systems operating at higher temperatures; and to improve dispatchability by deploying advanced thermal storage and hybridization concepts. New heat transfer fluids such as gases (e.g. direct steam generation) and molten salts are set to play an important role. RD&D efforts aimed at reducing the environmental footprint of solar operations are also under way, notably through the introduction of dry cooling designs to limit water consumption.

CSP is currently less mature than PV or Wind turbines, and receives the smallest share of public R&D funding for renewables in the OECD. As a result, innovation has been limited: patent rates declined after 1977 and did not return to that level until 2000. The IEA advocates long-term funding for research, development & demonstration in all the main CSP technologies.

| As a capital-driven technology, CSP's competitiveness is likely to benefit from the significant cost reductions expected as a result of commercial deployment

CSP is a capital-intensive technology. Initial investment, dominated by solar field equipment and labor, ranges from 2,500 to 10,200 USD per kW - mainly depending on capacity factor and storage size - and accounts on average for 84% of the electricity generation costs of CSP. The remaining 16% consist mainly of fixed Operation and Maintenance (O&M) costs. Fixed O&M averages around 70 USD per kW per year, while variable maintenance is limited to around 3 USD per MWh.

Depending on the boundary conditions, in particular solar irradiation resource, the levelized cost of electricity (LCOE) from CSP ranges from 140 to 360 USD per MWh. The quality of the solar resource has a strong impact on the economics of CSP. Locating a plant with a solar irradiance of 2,700 kWh/m² would decrease the generation cost by 25% compared with the same plant with 2,100 kWh/m². As CSP costs are dominated by the initial investment, generation costs are very sensitive to the financing costs. Despite requiring a higher initial investment, thermal storage tends to reduce the electricity cost by increasing the capacity factor: storage typically increases the number of full-load hours of CSP from around 2,000 to 3,500-5,000 hours per year.

Economies of scale, declines in component costs due to mass production and improvements in materials, and higher process and technology efficiency are expected to result in a fall in the cost of electricity from CSP of up to 55% within the next two decades. Widespread deployment is now essential if the industry is to benefit from the learning curve and create a virtuous circle.

Reflecting the paucity of installed capacity, investment in CSP is still very limited, with 18 USD billion invested in 2011 compared with 125 USD billion for solar PV and 84 USD billion for Wind over the same period. German, Spanish and US companies are the key industrial players.

| Concentrating Solar Power is a very low carbon technology but requires cooling water

CSP is one of the lowest GHG-emitting energy technologies, with median, full-lifecycle emissions ranging between 20 and 30 g CO₂ equivalent per kWh depending on site conditions and technology. In addition, when combined with heat-energy storage, CSP's energy output is less variable than that of wind turbines or solar PV. CSP could, therefore, reduce the need for dispatchable power plants - which often run on natural gas or another fossil fuel – to balance the intermittency of renewables.

Like any thermal power plant, CSP needs water for cooling processes, which may have a significant environmental impact in arid and semi-arid areas. Dry cooling, an established technology in conventional power plants, can already reduce water consumption by more than 90%, resulting in an increase in electricity-generation costs of 5%. So far in 2013, four large plants with dry-cooling technology have become operational in the MENA region: three Integrated Solar Combined Cycle plants in Hassi R'mel (Algeria), Kuramayyat (Egypt), and Ain Beni Mathar (Morocco) and the 100 MW Shams 1 in the UAE.

| CSP with thermal storage has the ability to be a non-intermittent renewable technology

Current trends suggest that, in the short to medium term, CSP electricity is likely to be consumed in the region where it is produced. In the longer term, greater potential could be captured through the creation of long-range electricity transmission systems, connecting the most productive solar resources and arid land with consumption centers. As a result, it is highly likely that CSP will be used in conjunction with High Voltage Direct Current (HVDC) transmission technology. HVDC is already commercial and plays a central role, alongside CSP, in the Desertec program. However, long-distance transmission will add significantly to costs. It will also take a long time to develop, and may face public acceptance issues.

The ability of CSP plants to store energy gives CSP a significant advantage over intermittent renewables. CSP with thermal storage avoids the balancing needs and associated costs incurred by Solar PV and Wind farms, and can even act as a dispatchable plant to help integrate intermittent sources of supply.

- 1. Key Concepts of Concentrating Solar Power** **6**
 - 1.1 Solar energy 7
 - 1.2 Design and components..... 12
 - 1.3 Concentrator technologies..... 13
 - 1.4 Applications..... 18
- 2. Status & Future Development...** **22**
 - 2.1 Installed capacity 23
 - 2.2 Project pipeline..... 26
 - 2.3 International scenarios..... 29
- 3. Research, Development & Demonstration**..... **32**
 - 3.1 RD&D priorities..... 33
 - 3.2 R&D funding..... 39
- 4. Economics, Financing and Key Players** **42**
 - 4.1 Investment costs..... 43
 - 4.2 Operation & Maintenance costs..... 45
 - 4.3 Levelized cost of electricity..... 46
 - 4.4 Financing..... 54
 - 4.5 Key players..... 55
- 5. Environmental & Social Impacts**..... 56
- 6. Grid-integration** 60
- Appendix & Bibliography**..... 64

1. Key Concepts of CSP

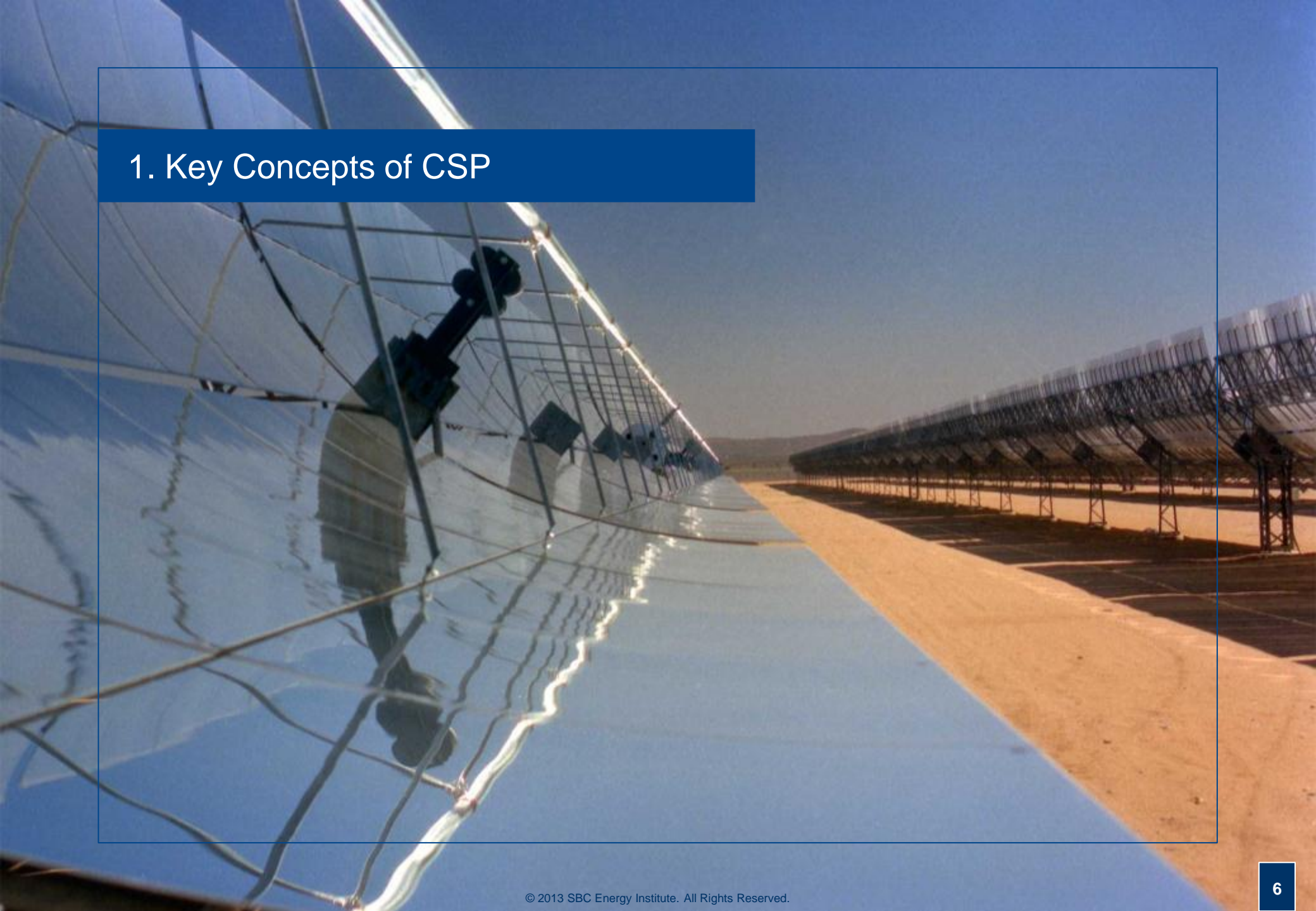

Solar is one of the most abundant resources in the world

GLOBAL TECHNICAL POTENTIAL OF ENERGY SOURCES

Exajoule (10^{18} Joules) per year, log scale

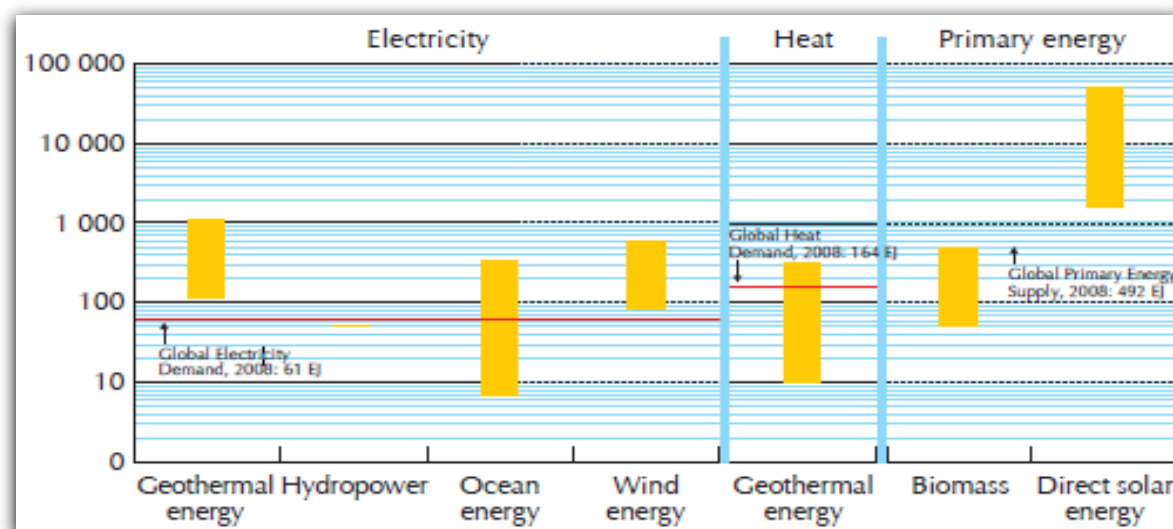

- The energy received from the sun in a single year, if entirely captured and stored, would represent more than 6,000 years of total energy consumption.
- Solar rays can be categorized in terms of the wavelengths that determine visible light, infrared and ultraviolet (respectively ~40%, 50% and 10% of the radiated energy).
- There are two main methods of capturing energy from the sun:
 - **Heat:** irradiative solar energy is easily transformed into heat through absorption by gases, liquids or solid materials;
 - **Photoreaction:** solar radiation can be viewed as a flux of elementary particles that can promote photoreactions and generate a flow of electrons.

CSP is one of the four main direct solar energy technologies

Concentrating Solar Power (CSP)

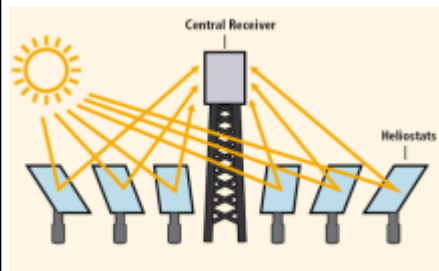

Electricity is generated by the **optical concentration** of solar energy, producing high-temperature fluids or materials to drive heat engines and electrical generators.

Solar Photovoltaic (PV)

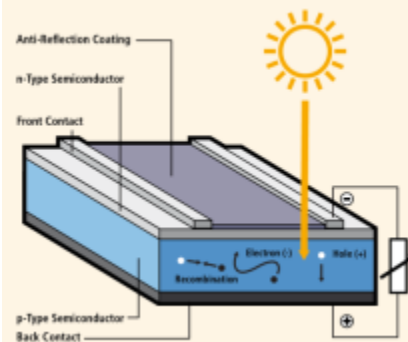

Electricity generation via direct conversion of sunlight to electricity by **photovoltaic cells** (conduction of electrons in semiconductors).

Solar Thermal

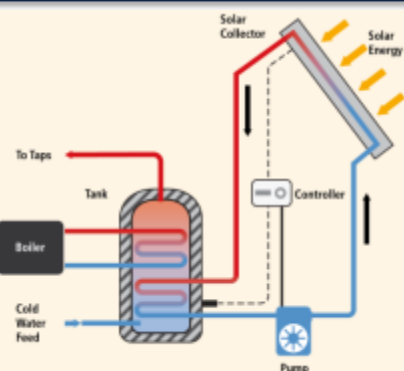

Solar panels made up of evacuated tubes or flat-plate collectors **heat up water stored in a tank**. The energy is used for hot-water supply and, occasionally, space heating.

Solar fuels

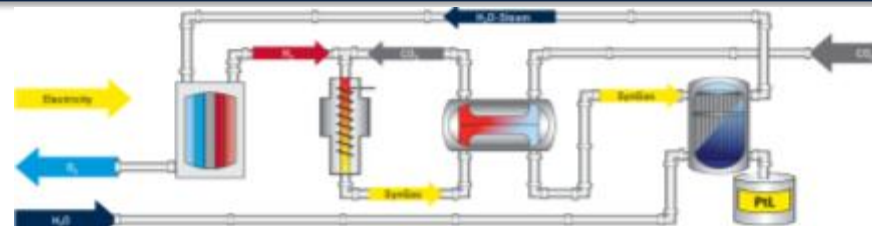

Solar Fuel processes are being designed to transform the radiative energy of the sun into chemical energy carriers such as hydrogen or synthetic hydrocarbons fuels (e.g. electrolysis, thermolysis, photolysis).

Note: Direct solar energy technologies exclude natural solar energy conversions, such as natural photosynthesis for biomass.

Source: IPCC (2011), "Special report on renewable energy"; IEA (2011), "Solar Energy Perspectives"; SolarFuel (<http://www.solar-fuel.net/>)

CSP plants use concentrated solar radiation to heat up a fluid, which drives a turbine, converting heat into mechanical energy and then into electricity

SOLAR CONCENTRATOR



- Solar heat has been harnessed as an energy source for a long time -- the first concentrating solar systems, using dishes, were built as early as 1878, in France.
- CSP involves the use of receptive surfaces to capture direct energy from sunlight.
- Concentrating solar rays is necessary in order to raise temperature. Higher temperatures increase the efficiency of the conversion of heat into mechanical motion and then electricity.
- Although the source of the heat is different, CSP uses the same conversion processes as conventional fossil-fuel power plants – the conversion of thermal energy into mechanical energy (turbine), and of mechanical energy into electrical energy (generator).

CSP technology depends on direct-beam irradiation, and its maximum benefit are thus restricted to high direct normal irradiance (DNI) areas

WORLD EXPOSURE TO DIRECT NORMAL IRRADIANCE (DNI) kWh/m²/year

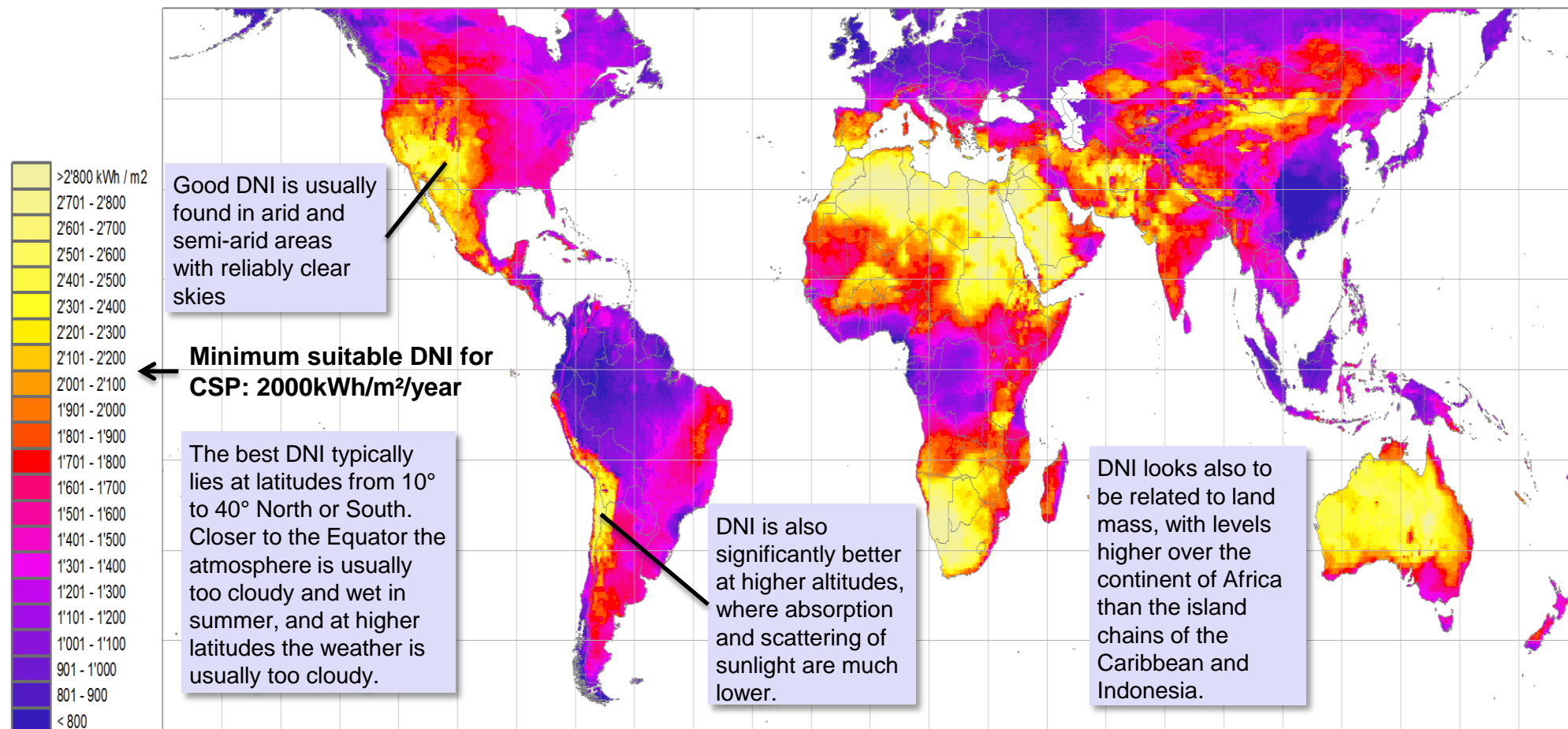

Note: Period: 1986-2005; grid cell size: 0.25°; Uncertainty: 15%.
Source: Meteonorm 7.0 (www.meteonorm.com)

The most promising regions for CSP are deserts in Africa, Australia and the Middle East

MOST SUITABLE SITES FOR CONCENTRATING SOLAR POWER

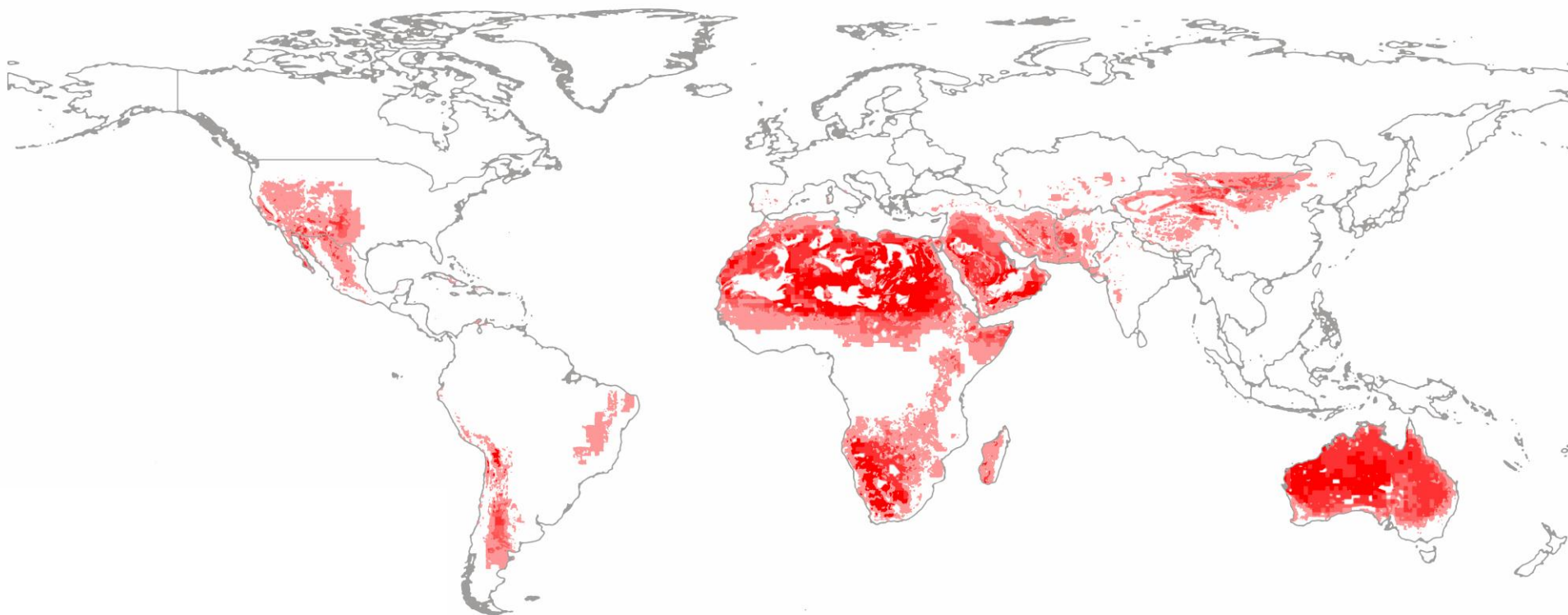

Note: Suitable sites refer to vast open areas of high direct normal irradiance.

Source: DESERTEC (2011) based on NASA and DLR data

CSP is a three-stage technology that has modular and scalable components and does not require exotic materials

CONVENTIONAL CSP PLANT WITH THERMAL STORAGE AND OIL AS WORKING FLUID

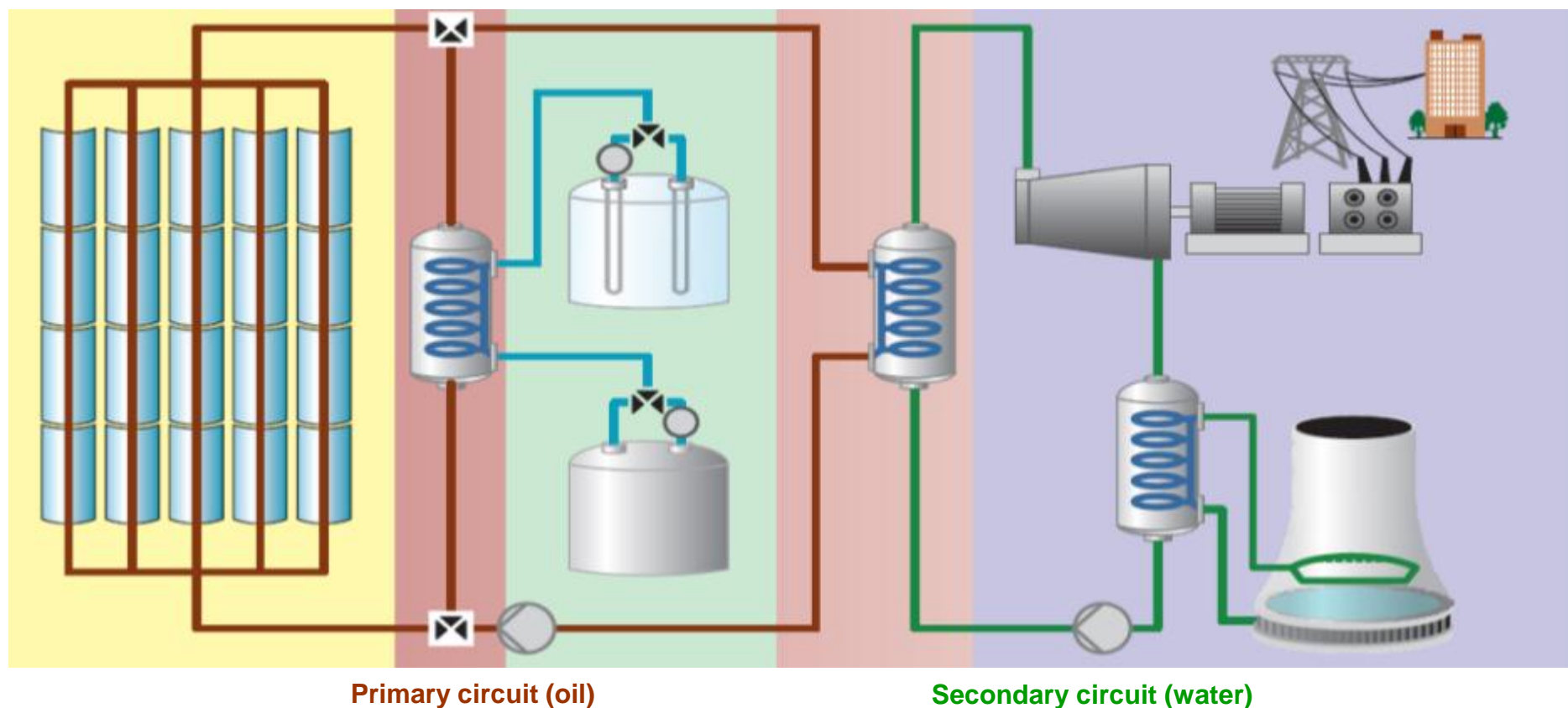

Source: IEA (2011), "Solar Energy Perspectives"

Four main sub-technologies coexist, distinguished by the way they focus the sun's rays and the technology used to receive the sun's energy

THE 4 CSP TECHNOLOGIES

Receiver mobility

Line focus

Point focus

Fixed

Receiver remains stationary and mechanically independent of the concentrating system, which is common for all the mirrors.

Tracking/aligned

Receiver and concentrating system move together. Mobile receivers enable an optimal arrangement between concentrator and receiver, regardless of the position of the sun.

Linear Fresnel

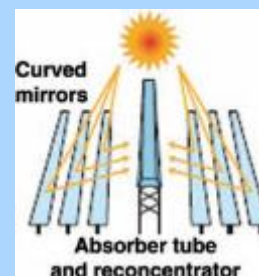

Solar Tower

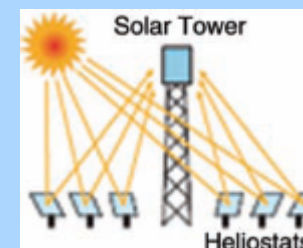

Parabolic Trough

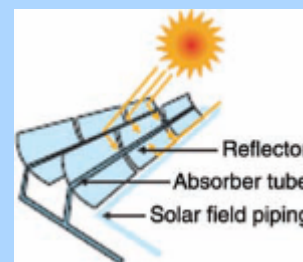

Parabolic Dish



Increasing optical efficiency

Increasing optical efficiency

Note: Tracking heliostats also exist.
Source: IEA (2011), "Solar Energy Perspectives"

Parabolic troughs are the most mature of the CSP technologies and form the bulk of existing commercial plants

PARABOLIC TROUGH

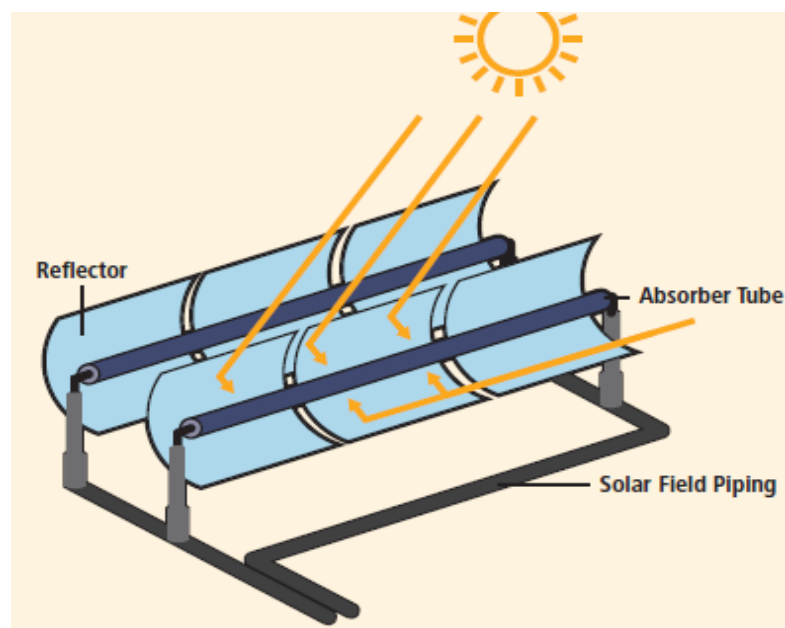

- Long rows of parabolic reflectors concentrate solar irradiance by an order of 70 to 100 times onto absorber tubes mounted along the reflectors' focal line.
- The absorber tube comprises a steel inner pipe with a glass outer tube with an evacuated space in between.
- Operating plants currently rely on synthetic oil as the heat fluid transfer from collector pipes to heat exchangers, where water is preheated, evaporated and then superheated.
- Superheated steam runs a turbine, which drives a generator to produce electricity. After being cooled & condensed, water returns to the heat exchanger.
- Around 30% of the plants in operation are equipped with thermal storage, sometimes supplemented by a back-up fuel.

+ -Good optical efficiency
-Storage possible

- -Medium solar-to-electricity efficiency* (15-16%)
-High water & land use requirement

Note: * Efficiency refers to the annual electricity output of the plant divided by the annual solar energy received by the reflectors.
Source: IPCC (2011), "Special report on renewable energy"; EASAC (2011), "Concentrating Solar Power"

Linear-Fresnel reflectors are less expensive than troughs but less effective when the sun is low

LINEAR-FRESNEL REFLECTORS (LFR)

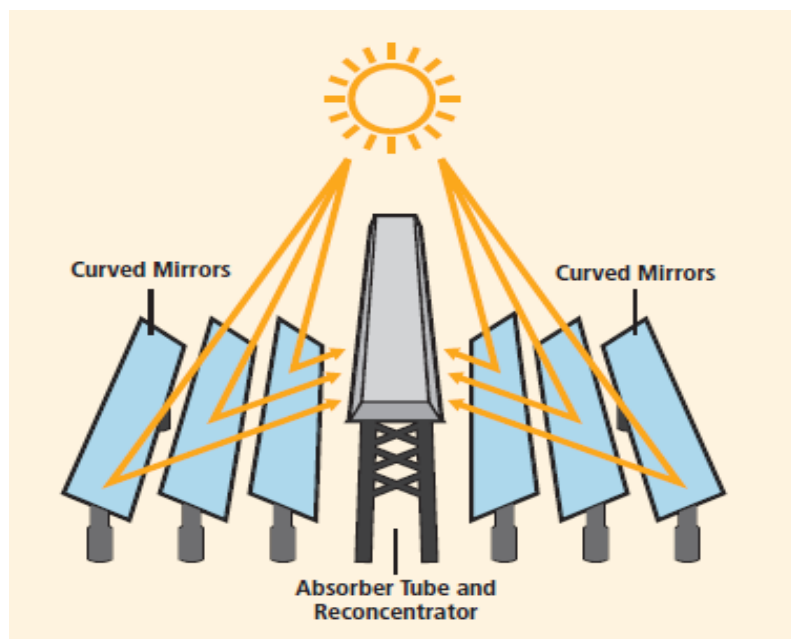

- Reduced land-use requirements
- Low cost
- Direct steam generation possible



- Low optical efficiency
- Lowest solar-to-electricity efficiency* (~8-10%)

- LFRs approximate the parabolic shape of trough systems but use long rows of flat or slightly curved mirrors to reflect the sun's rays onto a downward-facing linear, fixed receiver.
- LFRs have a lower optical efficiency than troughs due to greater cosine losses, making them less effective than troughs when the sun is low in the sky.
- Thanks to the high position of the receiver, collectors can be installed closer to each other, reducing the land-use footprint and cost.
- Fixed receivers allow higher pressures and thus facilitate the direct heating of water, a process known as direct steam generation technology. This can eliminate the need for and the cost of a heat-transfer fluid and exchanger.
- However, incorporating storage capacity into their design is challenging because it is more difficult to store the latent heat of steam than sensible heat.

Note: * Efficiency refers to the annual electricity output of the plant divided by the annual solar energy received by the reflectors.
Source: IPCC (2011), "Special report on renewable energy"; EASAC (2011), "Concentrating Solar Power"

Solar towers can offer higher large-scale concentration levels and flexibility

SOLAR TOWER

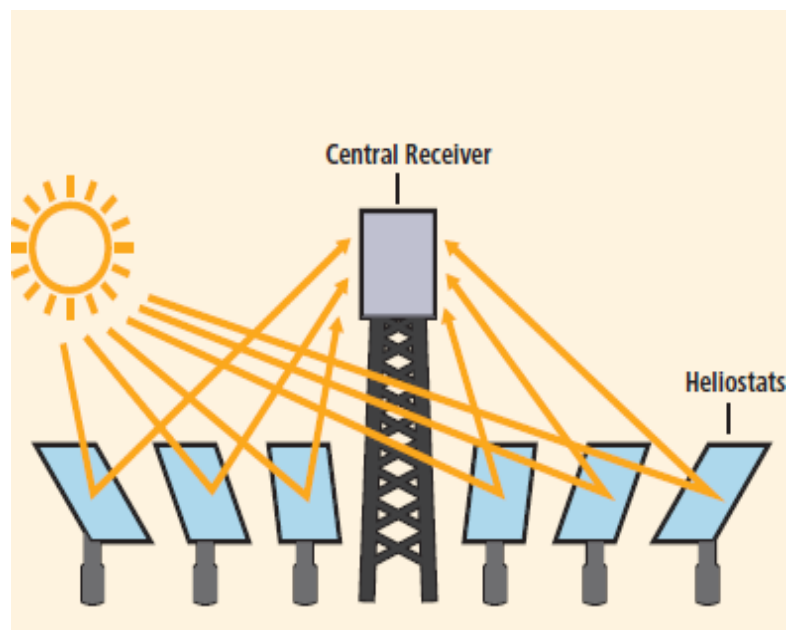

- + -Reduced water requirements
- High flexibility (back-up/storage/size)
- Medium solar-to-electricity efficiency* (12-20%)
- -More challenging scalability
- Less standardization

Note: * Efficiency refers to the annual electricity output of the plant divided by the annual solar energy received by the reflectors. Existing efficiency are in the range of 12 to 15%, and projected efficiencies for advanced tower projects are reported up to 20%.

Source: IPCC (2011), "Special report on renewable energy"; EASAC (2011), "Concentrating Solar Power"

- Solar towers - aka central receiver systems - are made of a field of heliostats (*i.e.* devices that track the sun from a stationary point), surrounding a central receiver atop a built structure.
- Heliostats can vary greatly in size, from about 1m² to 160 m². Whatever the size, field size seems to be limited to a thermal power of about 600 MW, for which heliostats are located about 1.5 km from a tower of about 160 m height.
- The choice of heliostat size creates a significant trade-off in benefits: large heliostats have a relatively high power output, but require stronger and more rigid structures; small heliostats are lighter and have smaller motors, but more of them are required to generate the same amount of electricity. There is no clear trend towards either option.
- Three Heat Transfer Fluid technologies are being developed: steam, which is difficult to store; molten salts, which induce more challenging fluid flows; and air, the simplest process technology.
- Going forwards, RD&D efforts will focus on harnessing the high temperatures that towers could attain, of over 1,000°C, to increase system efficiency, notably by deploying pressurized-air technology in combined-cycle designs.

Dish systems have the highest efficiency, but are generally more expensive than other systems, suitable on a small scale only and have limited storage capability

DISH SYSTEM

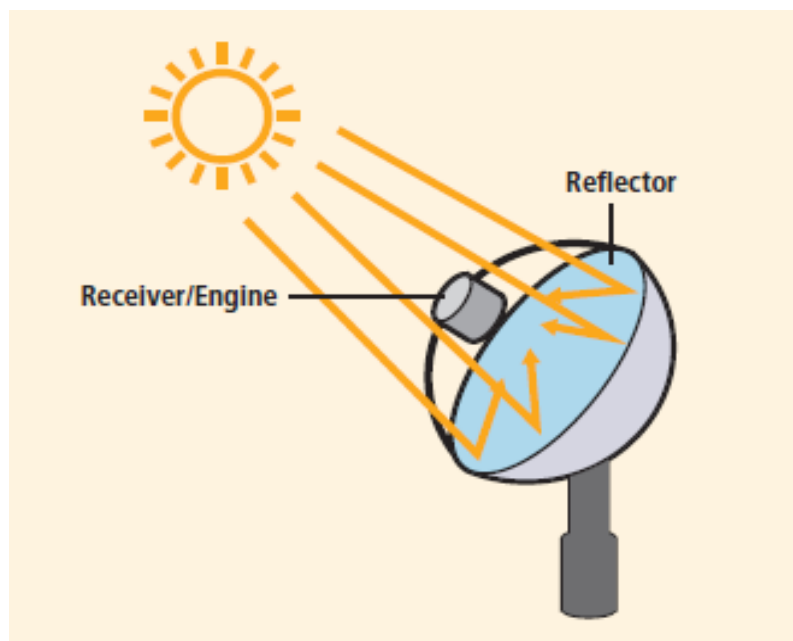

- No water cooling & very limited land use
- Modular concept suitable for decentralized applications
- High solar-to-electricity efficiency* (20-25%)



- Demonstration phase
- Storage limited to large dishes
- Costly

- Parabolic dishes concentrate the sun's rays at a focal point propped above the center of the dish. The entire apparatus tracks the sun, with the dish and receiver moving in tandem.
- Most dishes have an independent engine/generator at the focal point, which eliminates the need for a heat transfer fluid and cooling water. Dishes are in particular combined with Stirling engines.
- The modular design of dish systems tends to limit cost reductions achieved as a result of upscaling, resulting in a higher investment cost per unit of capacity installed than for other concentrator technologies.
- Dishes offer the highest solar-to-electric conversion performance of any CSP system, while having a low environmental footprint (land use & water requirement).
- Except where very large reflectors are used and in solar farms with a central power conversion unit, dish systems are not suited for thermal storage.
- Parabolic dishes are limited in size (typically tens of kW or smaller) and each produces electricity independently.

Note: * Efficiency refers to the annual electricity output of the plant divided by the annual solar energy received by the reflectors.
Source: IPCC (2011), "Special report on renewable energy"; EASAC (2011), "Concentrating Solar Power"

Thermal storage is an important feature of CSP, allowing variations in sunlight to be smoothed and plant capacity factors to be increased

INDIRECT STORAGE SYSTEM, OIL-BASED

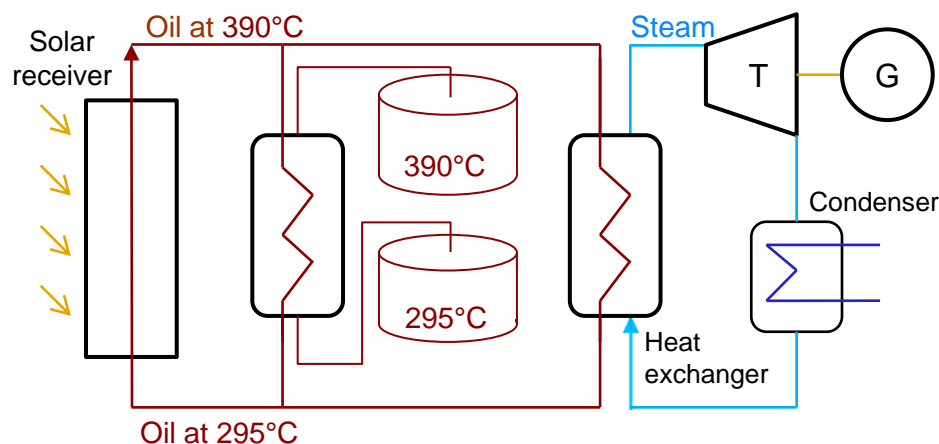

DIRECT STORAGE SYSTEM, MOLTEN SALT-BASED

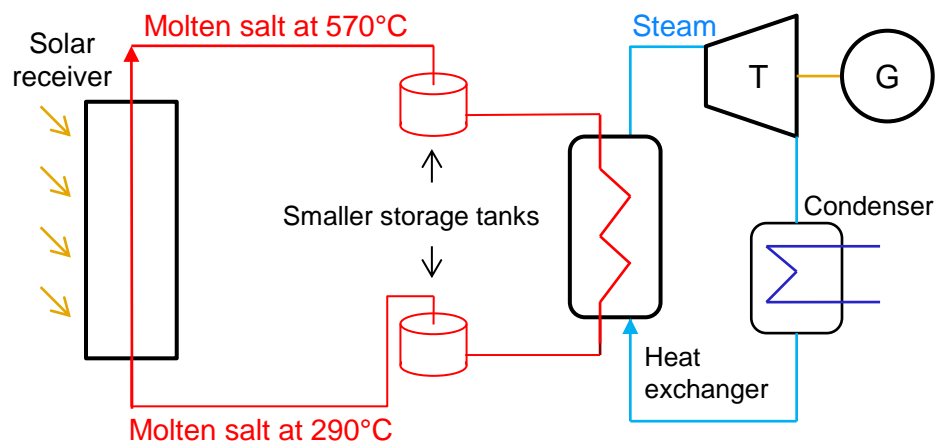

Note: T for Turbine and G for Generator.

*Note also that storage allows to prolong the lifetime of the conventional components.

Source: SBC Energy Institute; IEA (2011), "Solar Energy Perspectives"

- Storage has two main objectives:
 - **Firming** the capacity of the CSP plant: Second to minute storage to smooth the variability of the solar input to provide consistent output*;
 - **Time-shifting**: Hourly to daily storage to maximize electricity supply when demand and prices are high, and to minimize production when demand and prices are low.
- There are two main storage system configurations:
 - **Indirect storage systems** require an additional heat exchanger to store heat in a separate circuit, usually oil-based;
 - **Direct storage systems** include the storage tank directly in the primary circuit. This configuration preferably uses molten salt as working fluid instead of oil, to allow for higher temperature, smaller storage tank and higher steam cycle efficiency.
- Depending on its operating requirements, the **solar field needs to be sized so that enough heat can be supplied** both to operate the turbine during the day and charge the thermal storage system.

Almost all existing CSP plants use a back-up fuel to substitute or complement thermal storage

30 MW CSP PLANT WITH STORAGE & GAS BACK-UP SYSTEMS MW, Illustrative

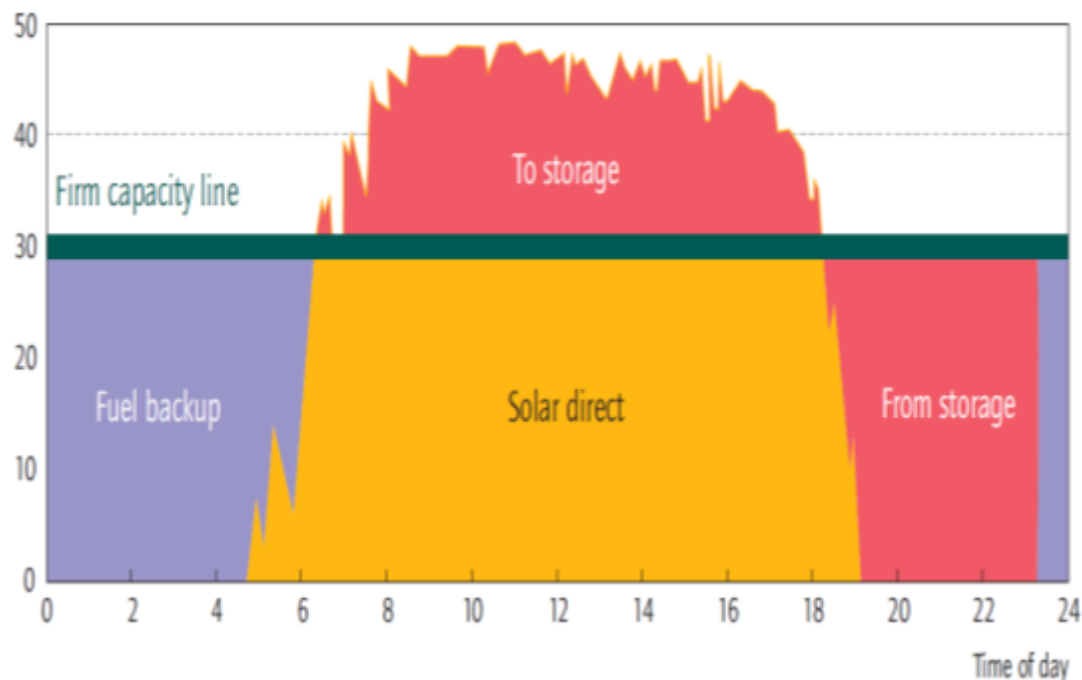

- **Back-up fuels provide energy to the heat transfer fluid or directly to the turbine to:**
 - Regulate and guarantee production by providing energy when irradiance & demand are decorrelated;
 - Boost the conversion efficiency of solar heat to electricity by raising the working temperature.

- **Both these cases can be economically and environmentally beneficial, as the back-up fuel optimizes the plant efficiency and limits the need for fossil-fired reserves:**
 - Natural gas accounts for only 18% of primary energy used in the SEGS CSP Plant in California, where it is used in case of low irradiance or to take over after sunset to leverage the mid-peak price;
 - Natural gas accounts for less than 25% of primary energy used in Shams-1 UAE where it is used continuously to raise the steam temperature.

CSP can also be hybridized by adding a solar field to existing or greenfield oil, coal or gas fired plants to displace fossil fuels

Option	Application	Illustration
1 PREHEAT FEEDWATER	Small solar field adjacent to a coal plant to provide medium temperature water to the coal boilers	2 GW Liddell coal power station in Australia, which added a 4 MW solar Linear Fresnel Reflector
2 PROVIDE HIGH-PRESSURE STEAM	Large solar field to provide additional steam to combined cycle thermal plants, called “Integrated Solar Combined Cycle” (ISCC)	Several ISCCs in operation in Egypt, Algeria, Morocco. Largest in Florida, with 75 MW
3 PROVIDE HIGH-PRESSURE SUPERHEATED STEAM	Large solar field to boost turbine during peak load, substitute fossil fuel when solar is available and benefit from conversion efficiency of ultra/super-critical steam turbine	Under development by EPRI with 245 MW Escalante Generating Station in Prewitt, New Mexico

- Hybridization is environmentally relevant as it displaces fossil fuels even in greenfield plants*. It is indeed more efficient to have a solar-coal hybrid plant than separate coal & solar plants. The use of CSP together with a fossil fuel is known as ‘fuel saver’ mode.
- Moreover, it is relatively low cost especially in brownfield plants* where Balance of System, power blocks and grid connections are already in place.
- Like biomass, CSP can be used in coal co-firing plants. However, biomass and CSP can be viewed as complementary as they would generally be applied in different locations (e.g. CSP is suited to arid and semi-arid areas, where biomass supply is obviously a challenge).

Note: * Greenfield plant refers to a new electric power generating facility built from the ground. Those plants which are modified/upgraded are called Brownfield plant.

Source: IEA (2011), “Solar Energy Perspectives”

On top of conventional generation, CSP can be applied to desalinate water, support Enhanced Oil Recovery or fuel remote facilities

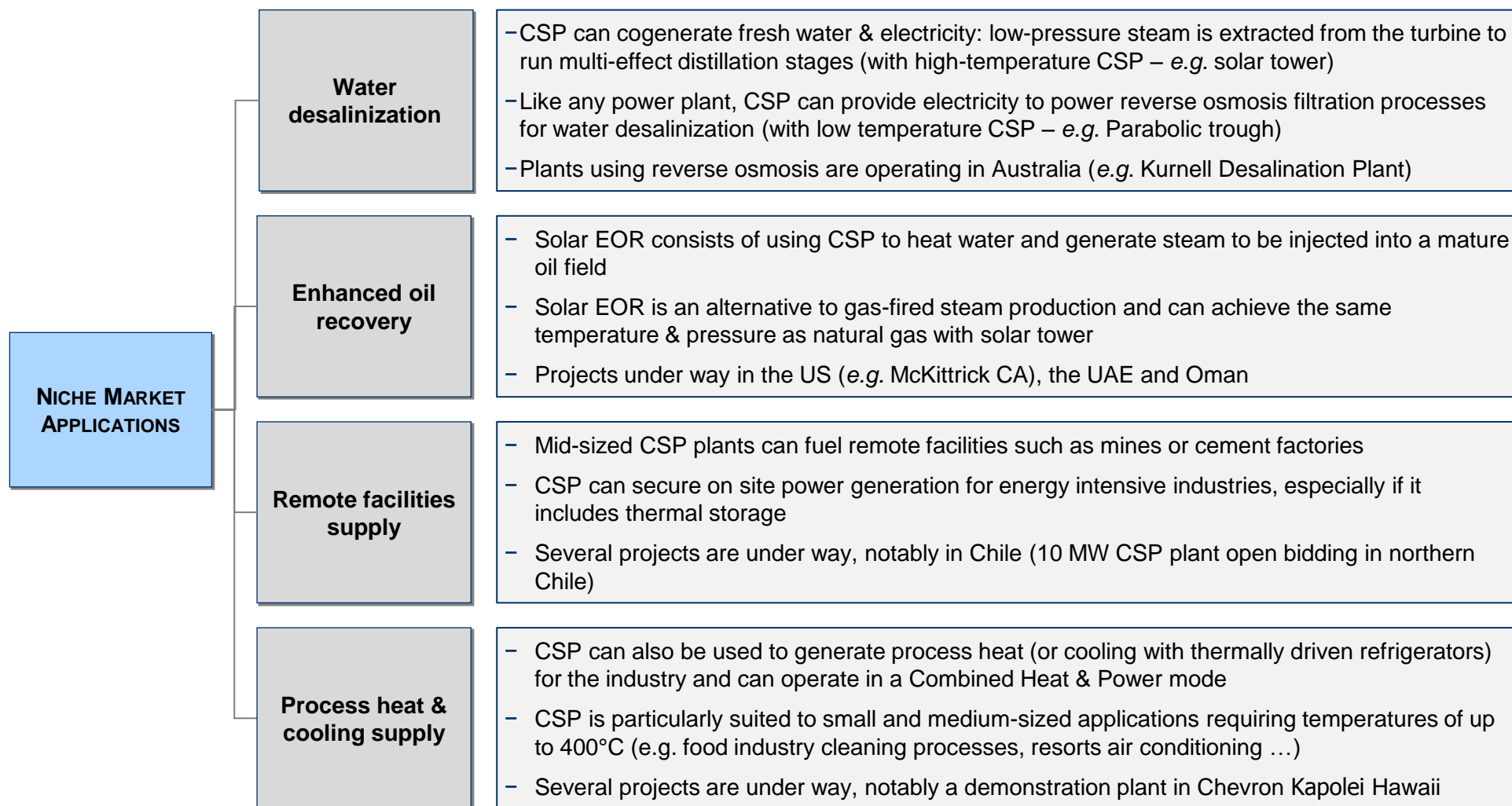

2. Status & Future Development



CSP reached 2.8 GW of installed operating capacity at the end of 2012

CSP DEVELOPMENT TIMELINE

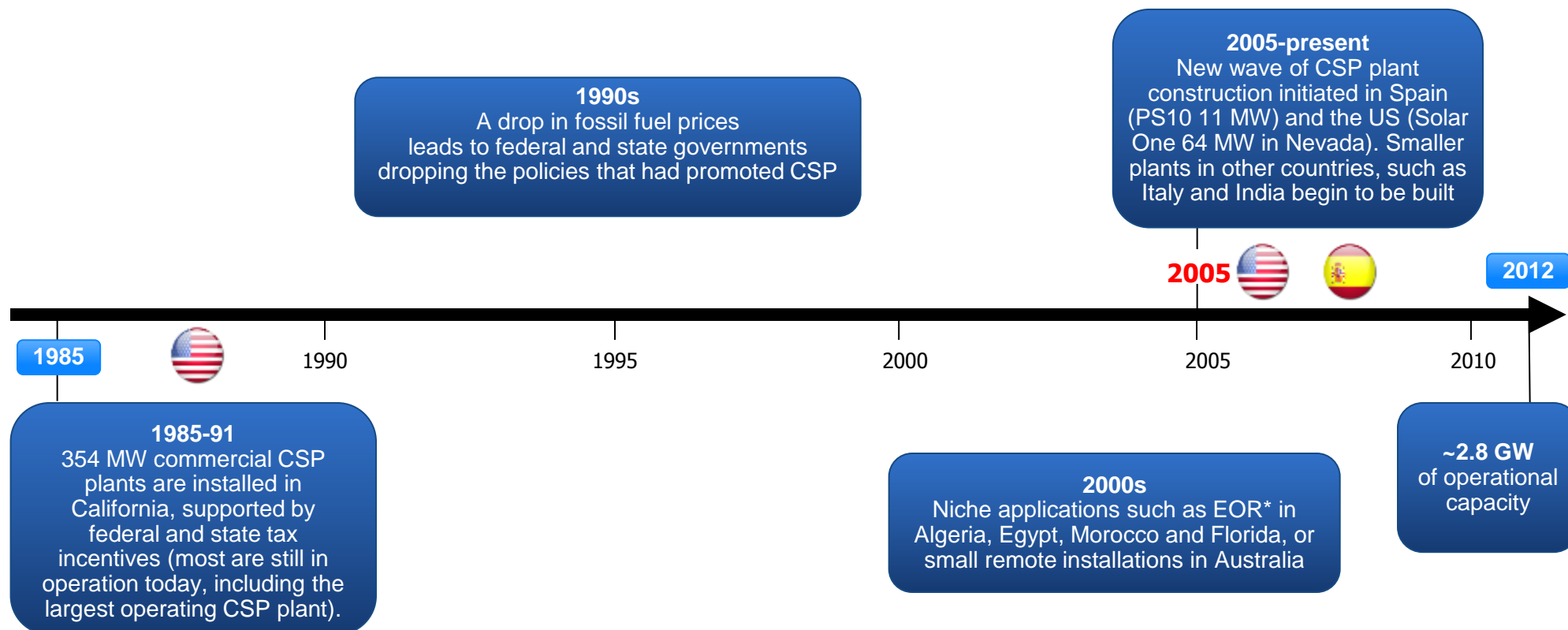

Note: * EOR for Enhanced Oil Recovery.
 Source: IEA (2011), "Solarpaces"

Spain and the US dominate the market, with 69% and 28% of installed capacity respectively

GLOBAL CUMULATIVE INSTALLED CSP CAPACITY
MW, 2007-2012

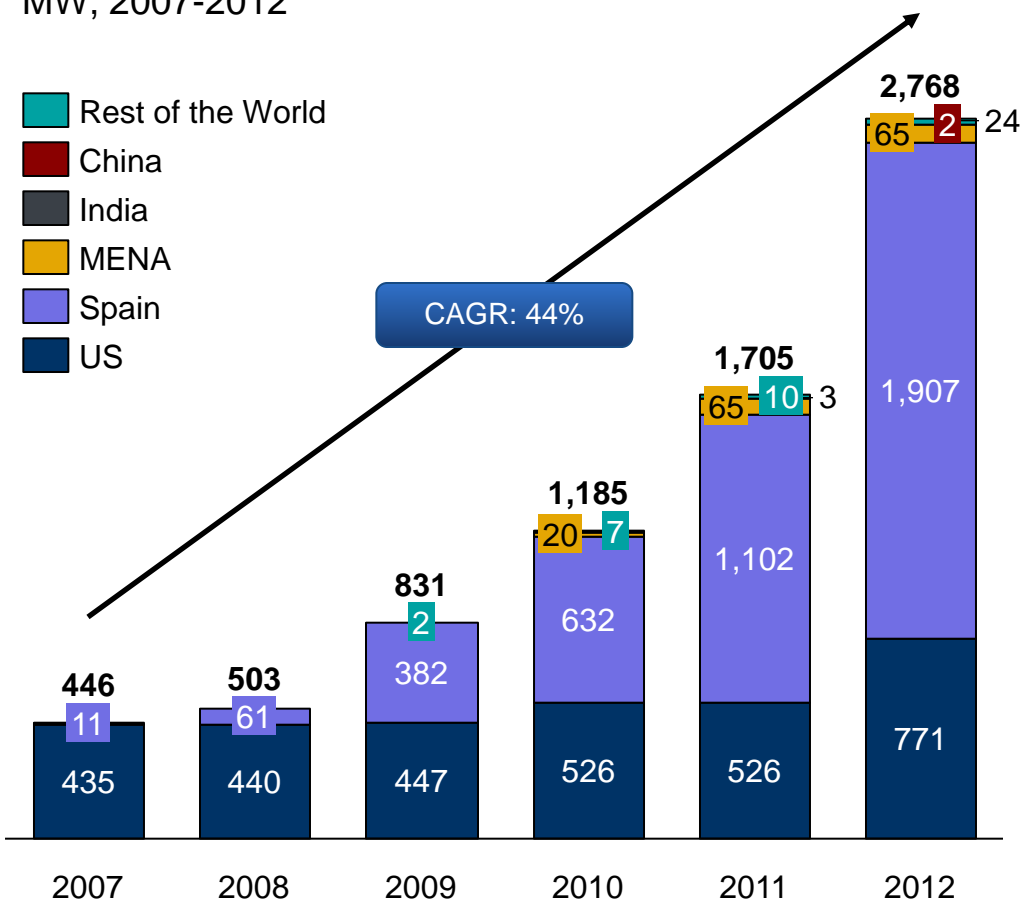

- US used to be the only actor in CSP until 2007 when Spain built its first plant (PS10).
- Spain then successfully developed 1.9 GW of CSP and now dominates the market with 69% of global installed capacity.
- Middle Eastern and African countries have commissioned 65 MW between 2010 and 2011 in Algeria, Morocco and Egypt. A additional 100 MW plant came on line in March 2013 in the UAE (Shams 1).
- China and India have started to show interest in CSP technology since 2010, with respectively 1.5 MW and 2.5 MW of capacity installed at the end of 2012.
- Plants with nominal capacities of 1 MW to 9 MW have also been developed in Australia, Thailand, France, Italy, and Germany.

Note: Figures for 2013 are estimated based on projects completed in the first quarter or under construction with a good probability to come on stream. Solaben 1, 3 and 6 in Spain, as well as Victorville and PHPP projects in the US have been excluded due to their low level of advancement.

Source: NREL SolarPaces database (http://www.nrel.gov/csp/solarpaces/by_project.cfm), BNEF Database, Protermosolar (<http://www.protermosolar.com/>)

In terms of annual growth, CSP is still below the target required to meet the IEA’s ambitious roadmap

GAP IN ANNUAL GROWTH RATE COMPARED TO IEA’S TARGETS FROM 450 SCENARIO

% of growth rate in installed capacity

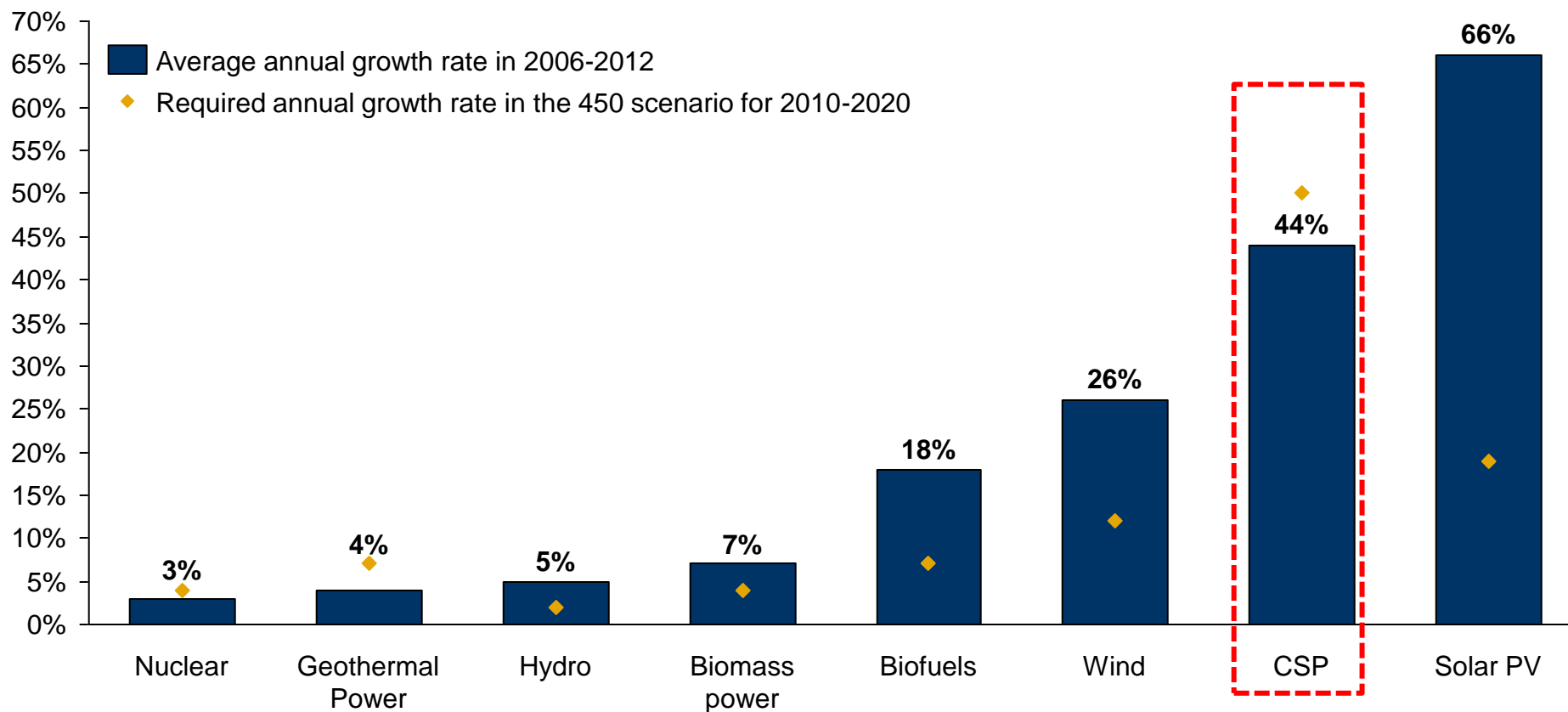

Note: Growth rate is a function of installed generation capacity (GW). The current biofuels growth rate is the annual average growth rate from 2005 to 2010. For biomass & geothermal, this period is 2004-2009. The current rate and status of nuclear includes capacity under construction up to 2015. Required growth rate in the 450 scenario is for the period 2010-2020.

Source: IEA (2012), "Clean Energy Progress Report"

The IEA estimates that 10.9 GW are likely to be operational by 2017

PROJECTED CSP INSTALLED CAPACITIES GW

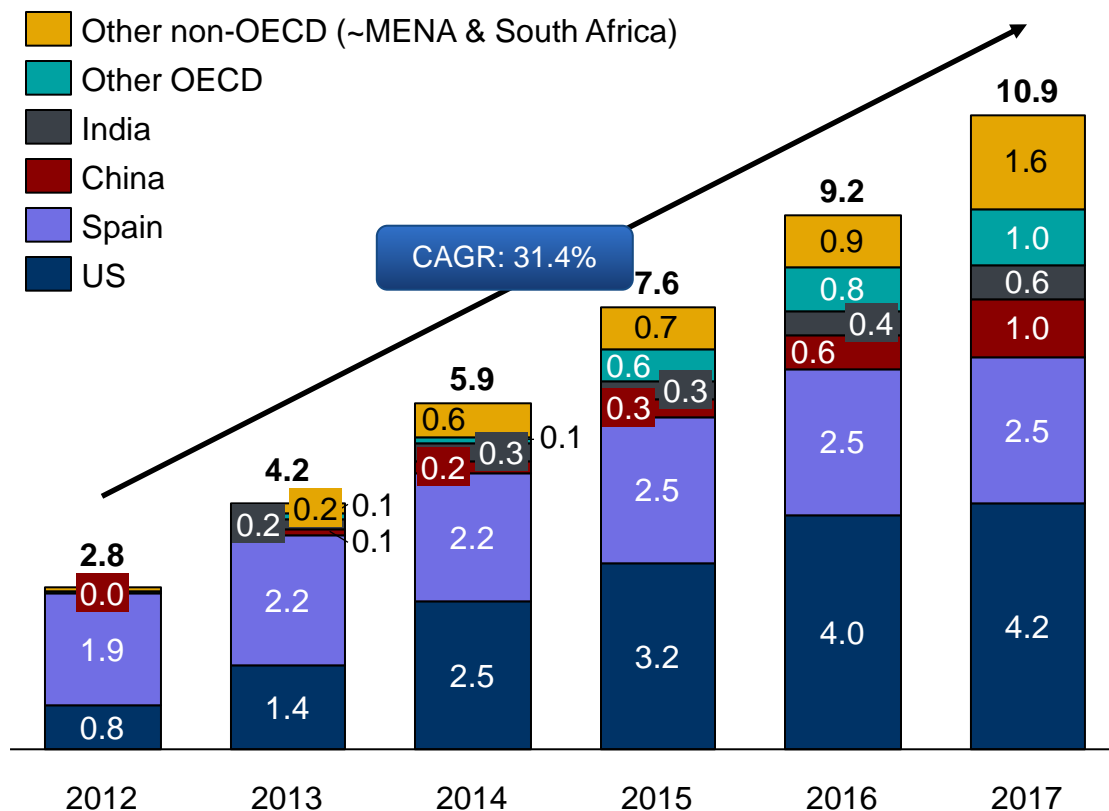

- Installed CSP capacity is expected to increase by almost four times between 2012 and 2017, although the growth rate may slow down after 2014.
- Although several projects have been abandoned or converted to PV as a result of a drop in PV module prices, the US should continue to drive the market, with 3.4 GW of capacity additions by 2017, while Spain's capacity growth is flattening out because of reductions in feed-in-tariffs.
- China is expected to become the third-largest operator of CSP capacity, with 1 GW installed by 2017, followed by India with 0.6 GW.
- Middle East and North African (MENA) countries are also likely to take a leading role in CSP development, together with South Africa. The main projects in these areas at present are: Shams 1 in the United Arab Emirates; Ouarzazate in Morocco; and Kaxu in South Africa.
- In the OECD, Chile, Australia and, to a lesser extent, Italy, France and Mexico may also develop CSP capacity.

Note: OECD for Organisation for Economic Co-operation and Development. Other OECD corresponds mainly to Australia, Chile, Israel, Mexico and European countries other than Spain (Italy, Greece, Turkey), while Other Non-OECD covers essentially Middle East and North Africa and South Africa.
 Source: IEA (2011), "Solar Energy Perspectives", IEA (2012), "Renewable Energy, Medium-term market report", SBC Energy Institute Analysis (2012)

India, China and Saudi Arabia have announced ambitious CSP plans and could overtake the US and Spain as the main drivers of growth in the near term

MAIN CSP PROGRAMS IN INDIA, CHINA AND MIDDLE-EAST & NORTH AFRICA

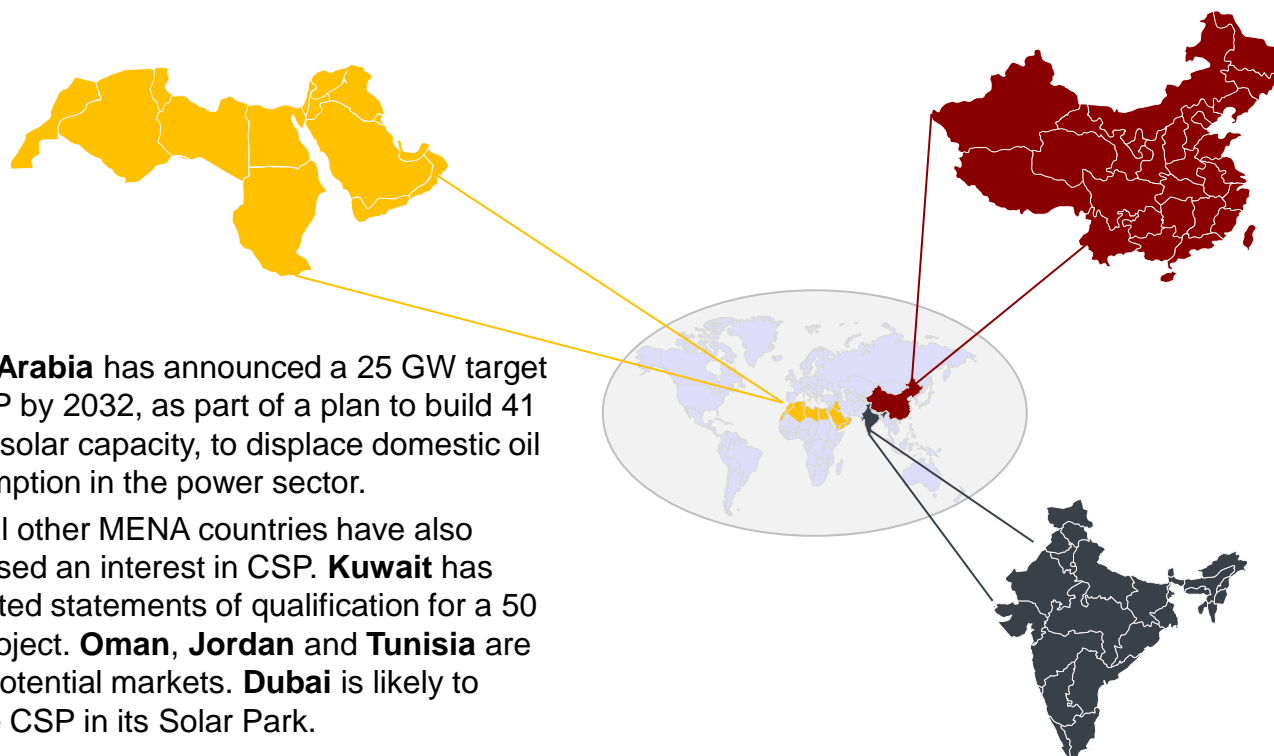

- **Saudi Arabia** has announced a 25 GW target for CSP by 2032, as part of a plan to build 41 GW of solar capacity, to displace domestic oil consumption in the power sector.
- Several other MENA countries have also expressed an interest in CSP. **Kuwait** has requested statements of qualification for a 50 MW project. **Oman, Jordan and Tunisia** are other potential markets. **Dubai** is likely to include CSP in its Solar Park.

As part of the 12th Five Year Plan, **China** is projected to install 3 GW by 2020. Additionally, two mega-plants may be constructed: a 1 GW plant in Qinghai and a 2 GW plant in Shaanxi.

India's Solar Mission proposes to develop 20 GW of solar capacity by 2022, in three phases. CSP will account for 50% of the first phase, of 1 GW*, and 30% of the second phase, of 10 GW. The split for the remaining 9 GW has not yet been announced.

Note: Around 500 MW are under construction.

Source: SolarPaces (2012), "Report on the 2012 SolarPACES Conference", NRDC (2012) "Concentrated Solar Power: Heating Up India's Solar Thermal Market under the National Solar Mission"

Parabolic trough and solar tower account for the vast majority of operational and projected CSP capacity

CSP PIPELINE PROJECTS BY TECHNOLOGY

% of total CSP projects

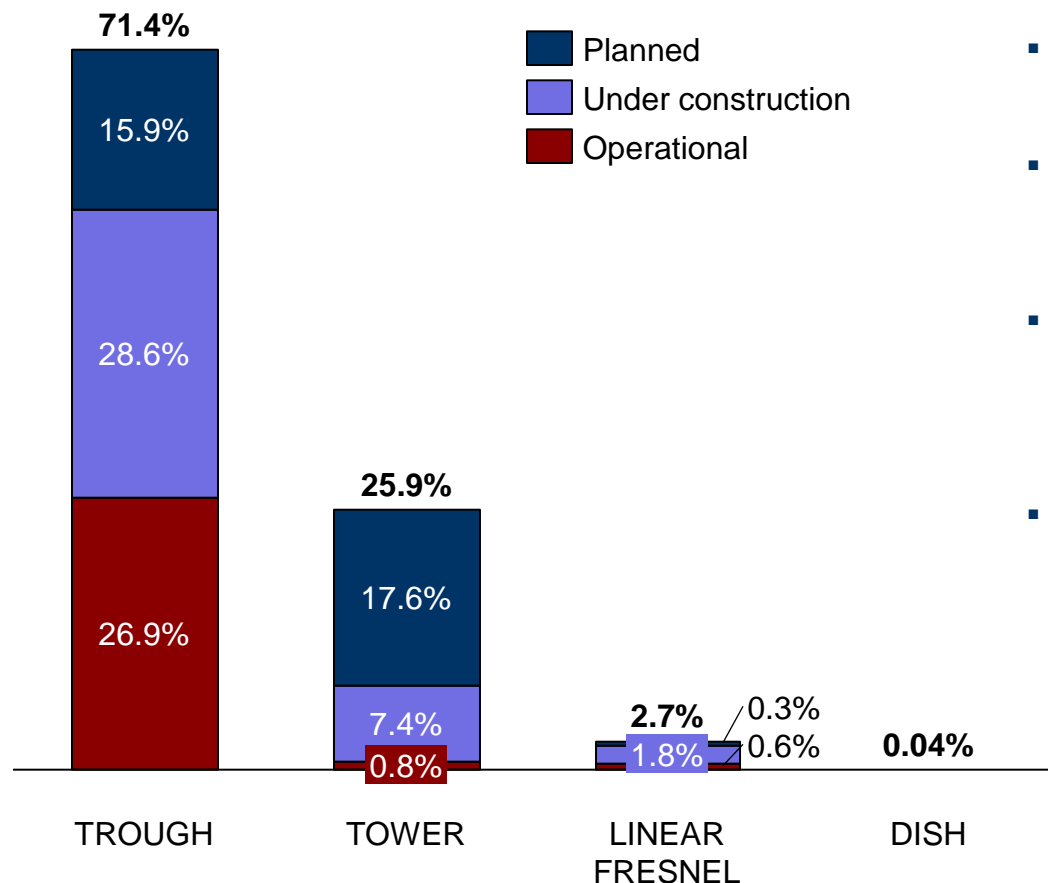

- Parabolic trough plants account for the vast majority of operational capacity due to their cost advantage.
- Solar tower systems are catching up, and account for around 20% of capacity under construction and 52% of planned projects.
- Linear-Fresnel is also starting to develop. The first large-scale plant is already in operation in Spain (Puerto Errado 2), and two are under construction (100 MW in Dhursar, India, and 44 MW Kogan Creek in Australia).
- Dish system is at an earlier stage of development and may take off later, depending on RD&D efforts.

Note: Based 100% for all planned, under construction or operational CSP Plants.

Source: IEA SolarPaces database, 1st March 2013

If its most ambitious climate-change mitigation scenario is to be met, the IEA believes CSP would need to account for 8%-10% of global electricity generation in 2050

IEA 2DS SCENARIO* FOR CSP CAPACITY

GW and % of global electricity generation

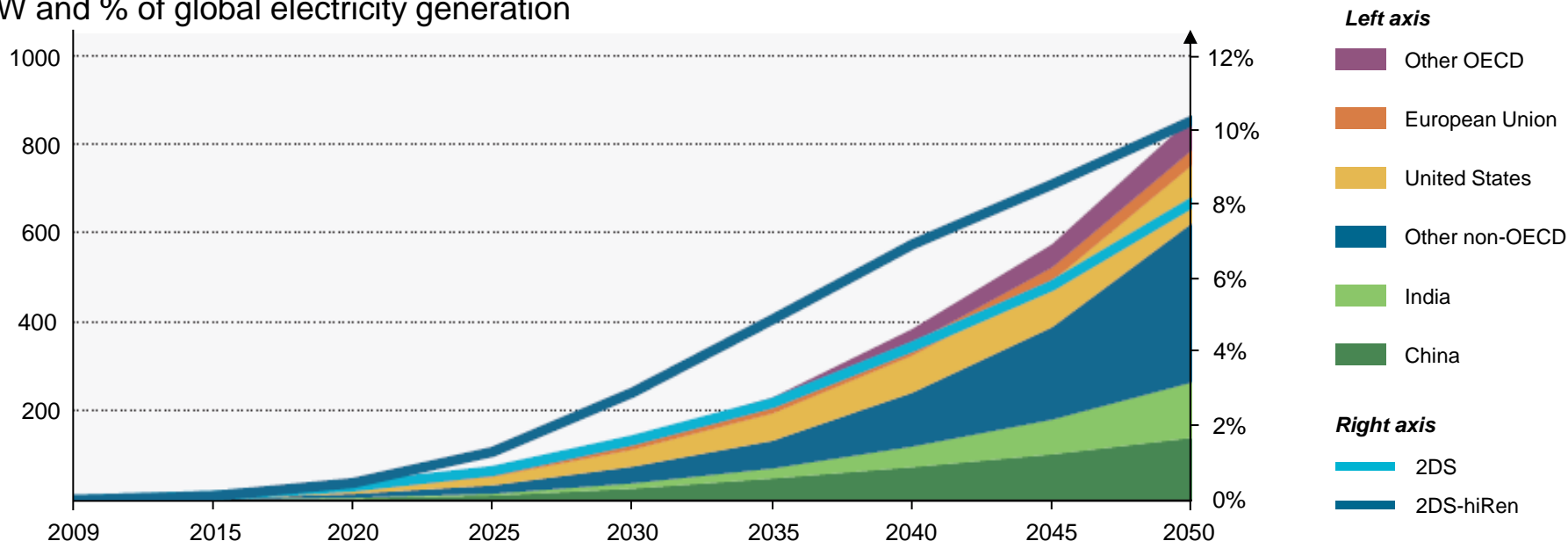

- CSP would need to account for 8%-10% of global electricity supply by 2050 in order to meet the IEA 2DS Scenario, compared with less than 0.01% in 2010.
- For CSP to supply 8% of electricity demand in 2050, installed capacity would need to reach 800 GW. By comparison, 2,000 GW of solar PV capacity is required in IEA 2DS Scenario, only to supply the same amount of electricity. Higher load factor for CSP explains this difference.
- The expansion of CSP capacity in developing countries is vitally important.

Note: * The 2DS Scenario corresponds to the lowest cost pathway towards an energy system consistent with an emissions trajectory that recent climate-science research indicates would give an 80% chance of limiting the average global temperature increase to 2°C. 2DS-hiRen is a variant of the 2DS with a higher share of renewables and a lower share of nuclear and carbon capture and storage. Colored areas showed in the graph represent the 2DS scenario.

Source: IEA (2012), "Energy Technology Perspectives"

CSP could be boosted by international programs set up to exploit high solar desert potential promoted by the Desertec Industrial Initiative

THE DESERTEC CONCEPT

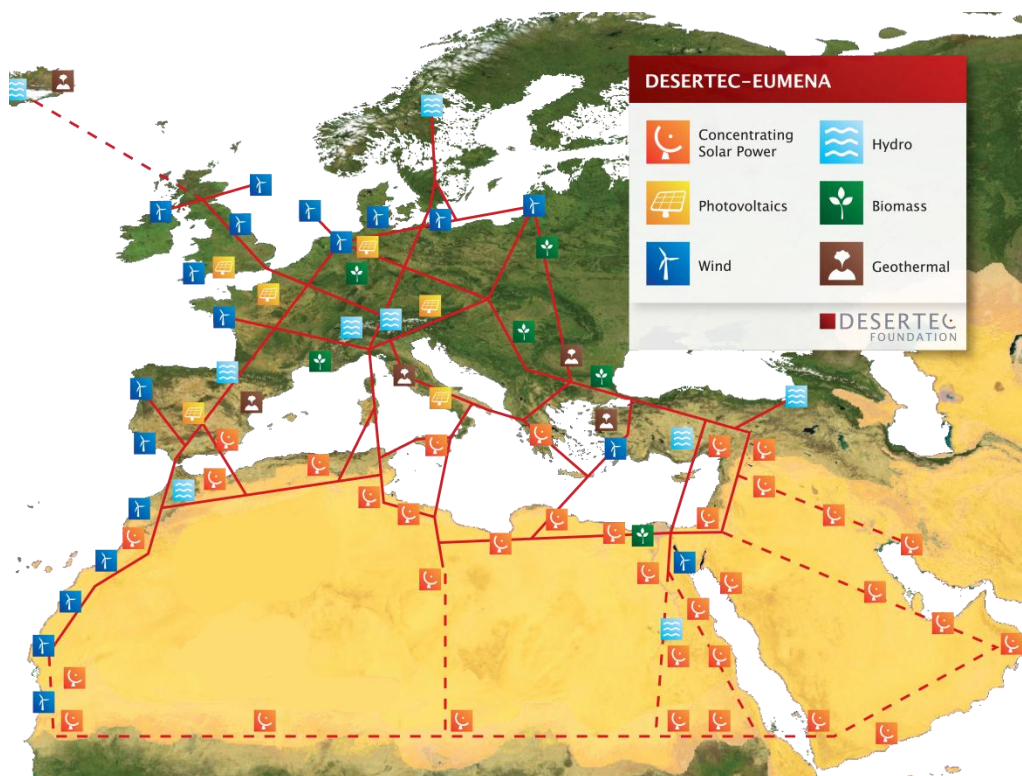

- CSP technology plays an important role in the framework of the DESERTEC* concept, which propagates an integrated European, Middle-Eastern and North African (EUMENA) electricity grid by 2050.
- The rationale of the project driven by the Desertec Industrial Initiative (DII)* is to harness solar and wind resources in the most favorable locations throughout EUMENA in order to minimize the costs of carbon emissions abatement, leading to reduction in electricity costs, and socio-economic benefits such as security of supply for the whole region. In that paradigm, CSP could contribute to 16% of the power mix of EUMENA (as modeled in the Desert Power Mix scenario), while being almost entirely located in the MENA.
- The DII is yet a controversial scheme. Opponents such as Hermann Scheer** argue that the project is unrealistic and potentially harmful. Most critics cite the monumental initial cost and the energy penalty of long-distance power transmission, but also security of supply concerns for Europe, arising from the MENA region's political stability.

Note: * The Desertec Industrial Initiative (DII) is a private-sector consortium proposed in 2009 by the Club of Rome with the support of the German Aerospace Center (DLR), which promotes large-scale renewable energy projects involving the European Union and Middle East and North Africa. DII is composed of powerful stakeholders and is dominated by companies such as German RWE, Munich Re or Deutsche Bank, but also Spanish Abengoa Solar, Swiss ABB or Algeria agro-food Cevital.

** The late Herman Sheer was s president of Eurosolar and of the International Parliamentary Forum on Renewable Energies.

Source: IEA (2011), "Solar Energy Perspectives"; EASAC (2011), "Concentrating Solar Power"

This page is intentionally left blank

3. Research, Development & Demonstration



The key is to optimize the thermal energy conversion cycle, while lowering costs

MAIN R&D AXIS BY COMPONENT



Concentrators & receivers:

- Seek an **alternative to conventional rear-silvered glass mirrors** (e.g. polymer-based films);
- Develop a **tracking system** to track the sun and ensure that reflection is optimized;
- Improve the **solar field set-up**.



Heat Fluid Transfer & Storage:

- Seek new **heat transfer fluids** and **storage media** (e.g. phase change material, molten salts);
- Develop **Phase Change thermal storage** for all direct steam generation solar plants.



Central receivers:

- Develop **air receivers** with Rankine or Brayton cycle;
- Develop solar tower with **ultra/supercritical steam cycle**;
- Develop **multi-tower set up**.

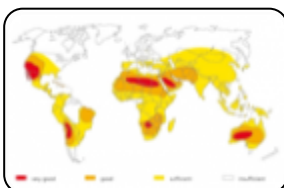

Develop ground and satellite modeling of solar resources:

- Improve satellite algorithms to obtain higher spatial resolutions to **map high DNI areas better**;
- Develop **sensor systems, computing systems and software** to optimize sun-tracking systems, adapt to the environment (such as high wind conditions), and to control engine use.

Innovations are expected across all four CSP technologies and along the entire system value chain

RD&D AXIS AND IMPROVEMENT POTENTIAL BY CSP TECHNOLOGY ALONG THE CSP VALUE CHAIN

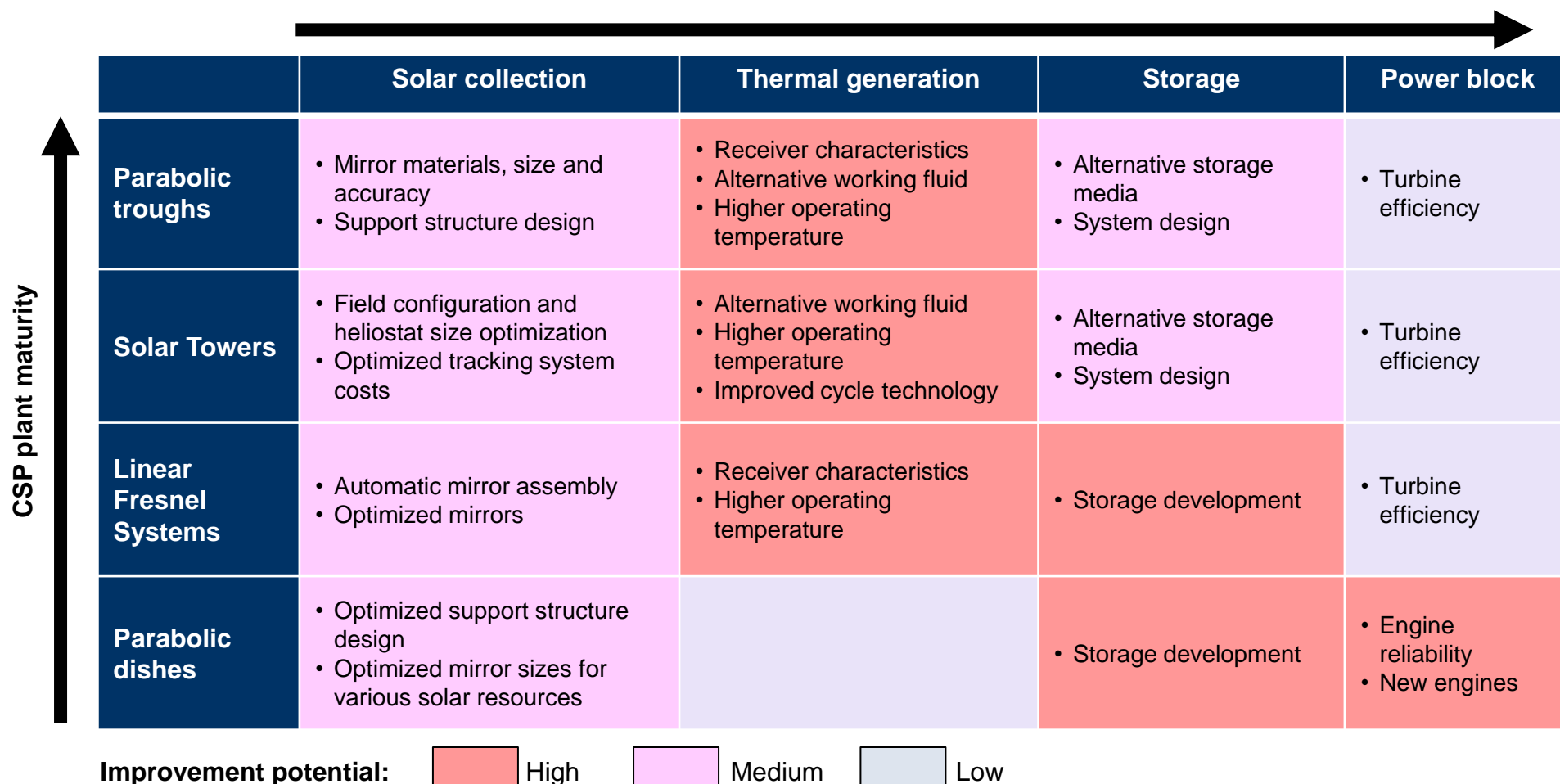

Although it has great potential to reduce the water consumption of CSP plants, dry cooling requires greater upfront investment and reduces plant efficiency

DRY COOLING – AIR COOLED CONDENSER

Illustrative

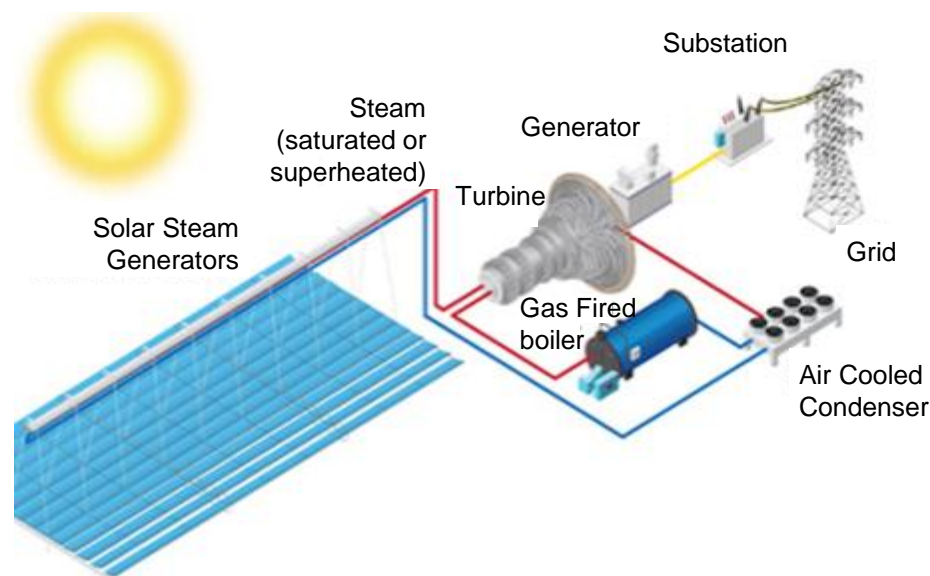

A parallel hybrid cooling system

- The main means of mitigating water consumption consists of using air instead of water to cool the steam.
- However, dry cooling is more costly than water cooling. Efficiency is reduced by up to 7% because more energy is required to power the fans and because higher re-cooling temperatures result in higher condensing pressures and temperatures. As a consequence, 2-10% more investment is required to achieve the same annual energy output as a water-cooled system.
- Hybrid wet/dry systems may be attractive, especially if dry cooling is used in winter when cooling needs are lower and hybrid in summer. Experiments show that such a system reduces water use by up to 50% for a 1% production penalty.
- Dry cooling is easier with Solar Towers.
- Alternative efforts have been undertaken, such as using non-traditional sources for cooling water (e.g. treated saline groundwater, reclaimed water, or water produced from oil and gas extraction).

Advances in thermal storage technologies could further improve the potential of CSP by increasing capacity factors and enabling systems to take advantage of peak electricity prices

PHASE CHANGE MATERIAL (PCM) FOR THERMAL ENERGY STORAGE

- ① Energy flows through the storage system consisting of many PCM capsules

- ② PCM capsules store and release heat in a phase change cycle

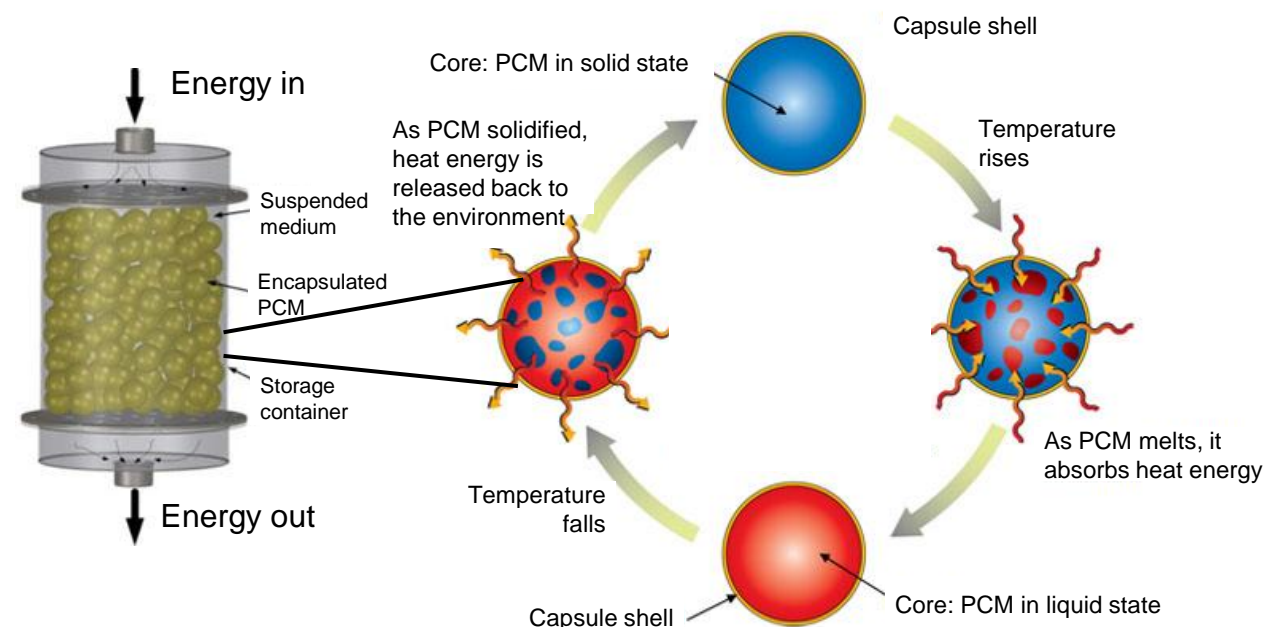

THREE COMPETING THERMAL STORAGE TECHNOLOGIES AND RELATED RD&D AXIS

- **Sensible heat**: collected heat raises the temperature of a heat medium:
 - Water: tank insulation;
 - Molten salts: low-melting-point salt mixtures; single-tank thermoclines, in which hot and cold molten salts are stored in one tank and separated by the difference in density between the hot and cold salts; Specially engineered additive materials such as dispersed nanoparticles within salts to increase heat capacity;
 - Solid-media storage: graphite, concrete, or ceramics.

Latent heat: heat changes the phase of a heat medium (PCM) upon storage and vice versa when extracted: materials, capsules designs...

Thermo-chemical: energy in which energy is captured using a chemical reaction ($AB \rightarrow A+B$), and, when needed, released by reversing the reaction. This relatively novel technology allows extremely high storage densities:

- Absorption systems, e.g. H_2O+NH_3 ;
- Adsorption systems, e.g. $H_2O+Zeolite$;
- Solid reaction: e.g. $H_2O+MgO \rightarrow Mg(OH)_2$.

Direct steam generation, which uses water as the direct working medium rather than oil, allows a higher process temperature and increases efficiency

CONVENTIONAL CSP PLANT (OIL BASED)

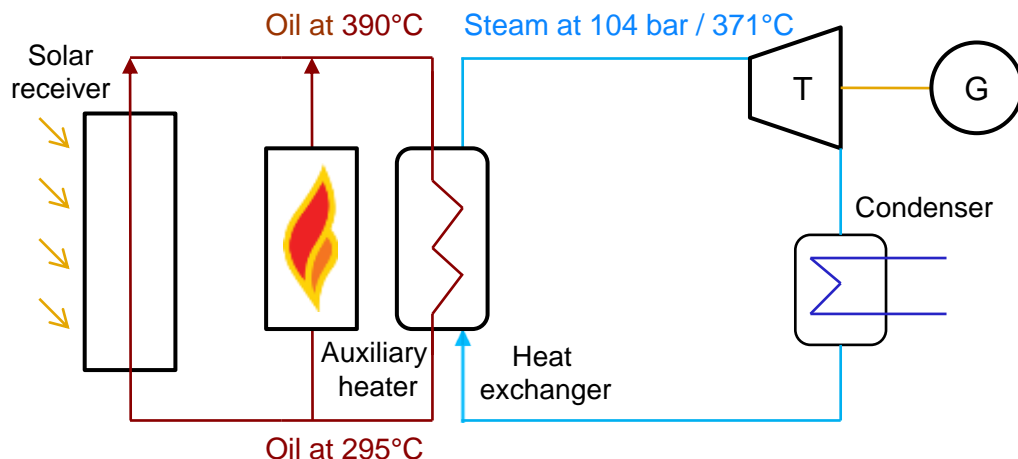

ADVANTAGES & DRAWBACKS OF DIRECT STEAM GENERATION

- Higher steam temperature (up to 500°C instead of maximum 390°C with oil) resulting in higher efficiency
- Lower investment and O&M costs due to simpler balance of plant configurations (no need to circulate a second fluid, which in turn reduces pumping power and parasitic losses)
- Reduced environmental risks because oil is replaced with water



DIRECT STEAM GENERATION CSP PLANT

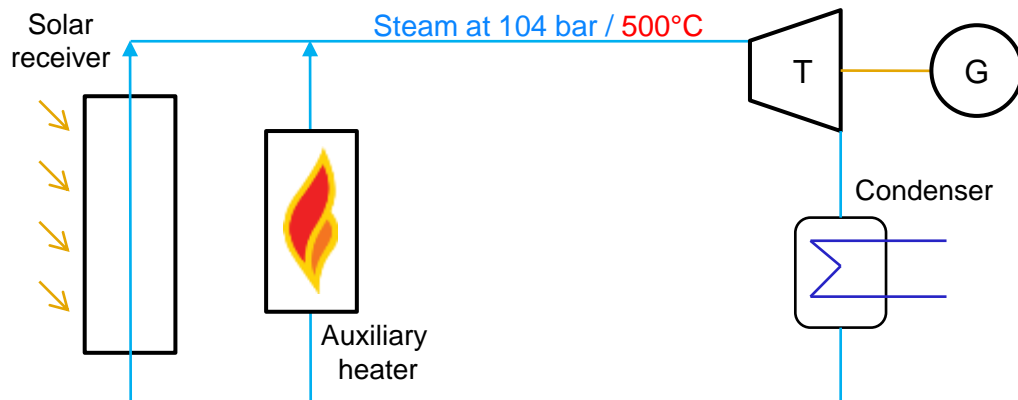

- Difficult to maintain a stable fluid flow under changes in solar radiation, which could damage the plant. Might require auxiliary (gas) heater
- Storing steam (latent heat) is more difficult than storing sensible heat
- Heat-receiver tubes need to sustain higher pressures



Note: T for Turbine, G for Generator and O&M for Operation & Maintenance.
Source: SBC Energy Institute

It took until 2000 for CSP patent rates to return to the 1977 level after two decades of limited innovation

PATENTING RATES BY CSP SUBSECTOR

Annual number of patents filed, 1976-2006

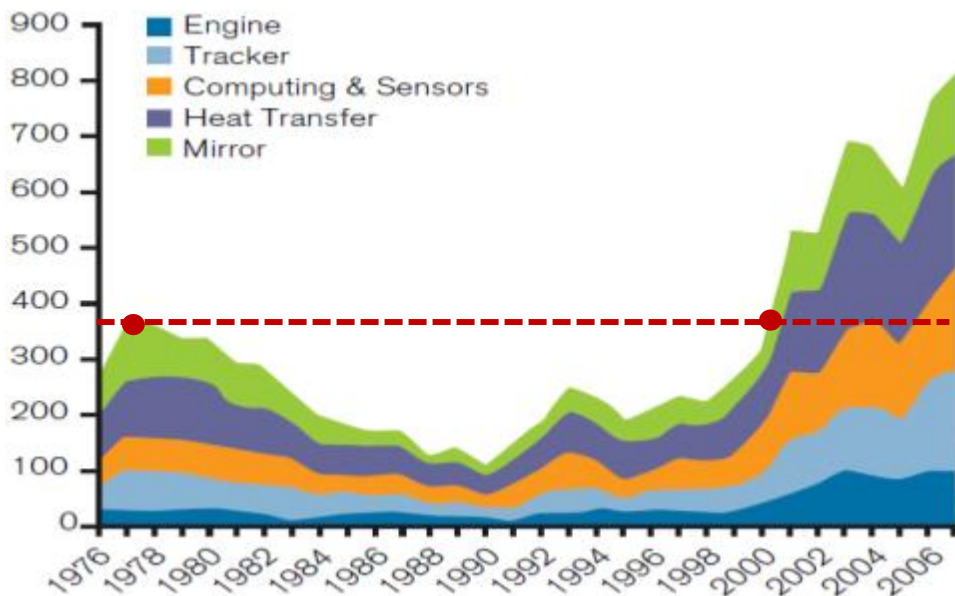

PATENT FILING LOCATION

Cumulated patents filed, 1976-2006

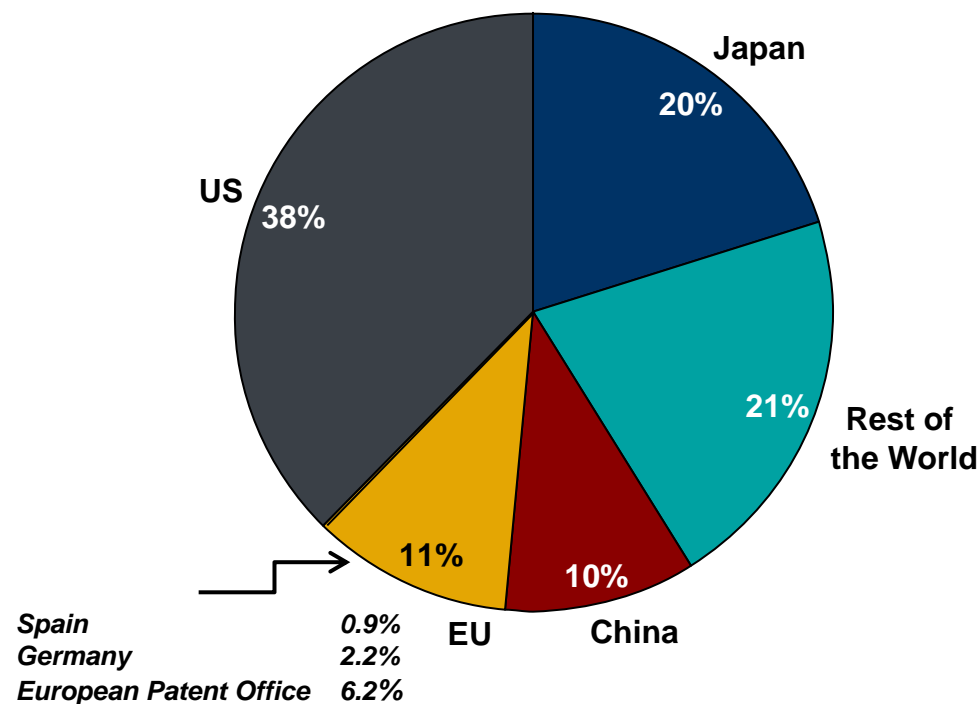

- Patenting rates is relatively well balanced among CSP subsectors. Heat transfer seems particularly attractive since 2000s.

- The US and Japan are the most important locations for patents filing, while China and Europe are lagging behind.

Investment in solar R&D is substantially higher than in other renewables

2008-2011 R&D INVESTMENTS IN SOLAR
USD billion

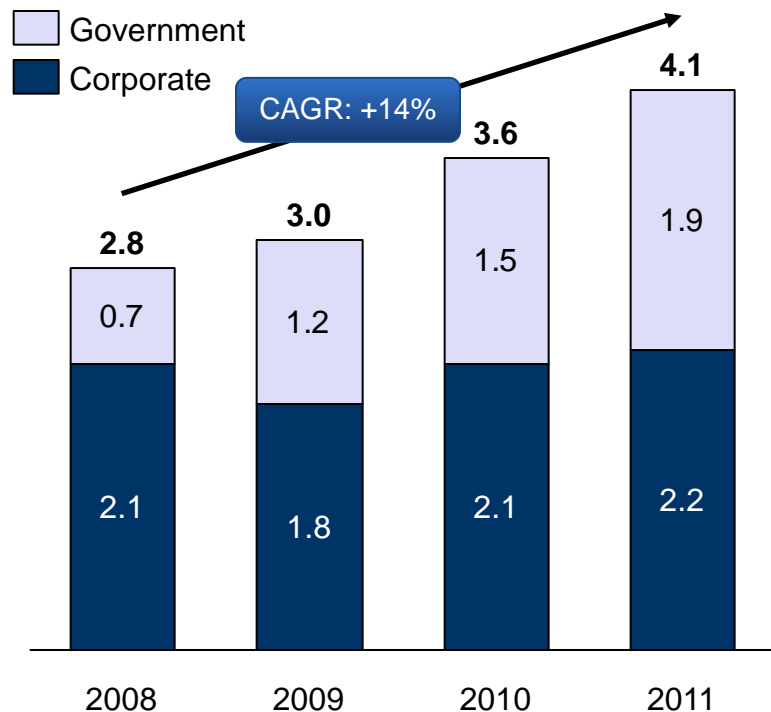

2011 R&D INVESTMENTS IN RENEWABLES
USD billion

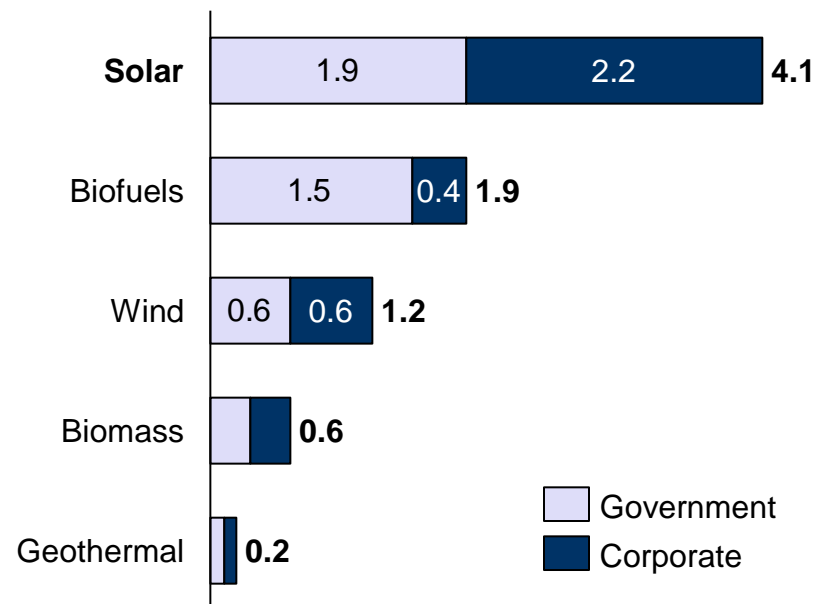

- Solar R&D funding has increased every year since 2008, benefiting from strong public support.

- Solar R&D funding is significantly higher than investment in other renewable technologies.

Note: **Caution: global breakdown of solar R&D investment between PV and CSP is not available. The ratio of public R&D funding for PV and CSP in the OECD is 5:1, in favor of PV.**

Source: UNEP (2012, 2011, 2010, 2009) "Global Trend in renewable Investment". Results based on Bloomberg, Bloomberg New Energy Finance, IEA, IMF, and various government agencies

In the OECD, CSP receives the smallest share of public R&D funding for renewables

OECD PUBLIC R&D FUNDING FOR RENEWABLES 2010

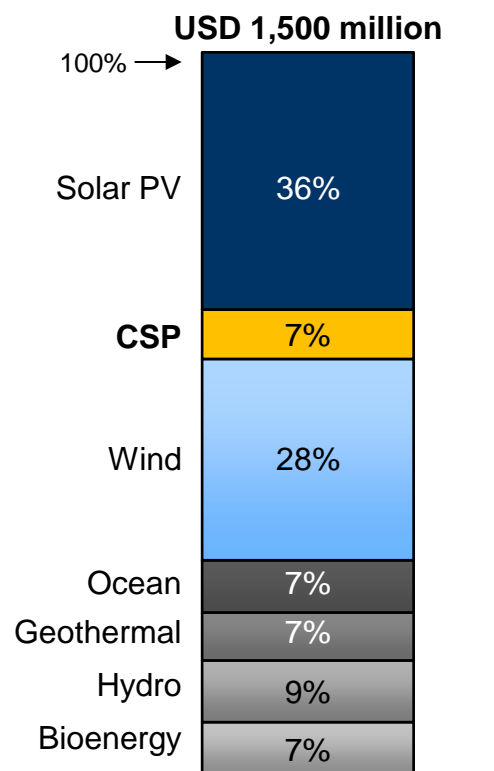

PUBLIC OECD R&D FUNDING FOR CSP 2010

- Total public R&D funding for CSP in the OECD reached 104 USD million in 2010 versus 542 USD million for Solar PV and 424 USD million for Wind.
- CSP is less mature than Solar PV and Wind. As a result, the IEA estimates that CSP requires continued government investment in R&D, coupled with support to foster early deployment.
- The US, Europe and Australia account for most of public R&D funding, despite the recent interest of China, South Korea, Abu Dhabi (with Masdar) and Chile.

This page is intentionally left blank

4. Economics, financing & key players



CSP is capital intensive, with initial investment ranging from 2,500 to 10,200 USD/kW

EXAMPLE OF CAPITAL COST ESTIMATES FOR CSP PLANTS USD / kW

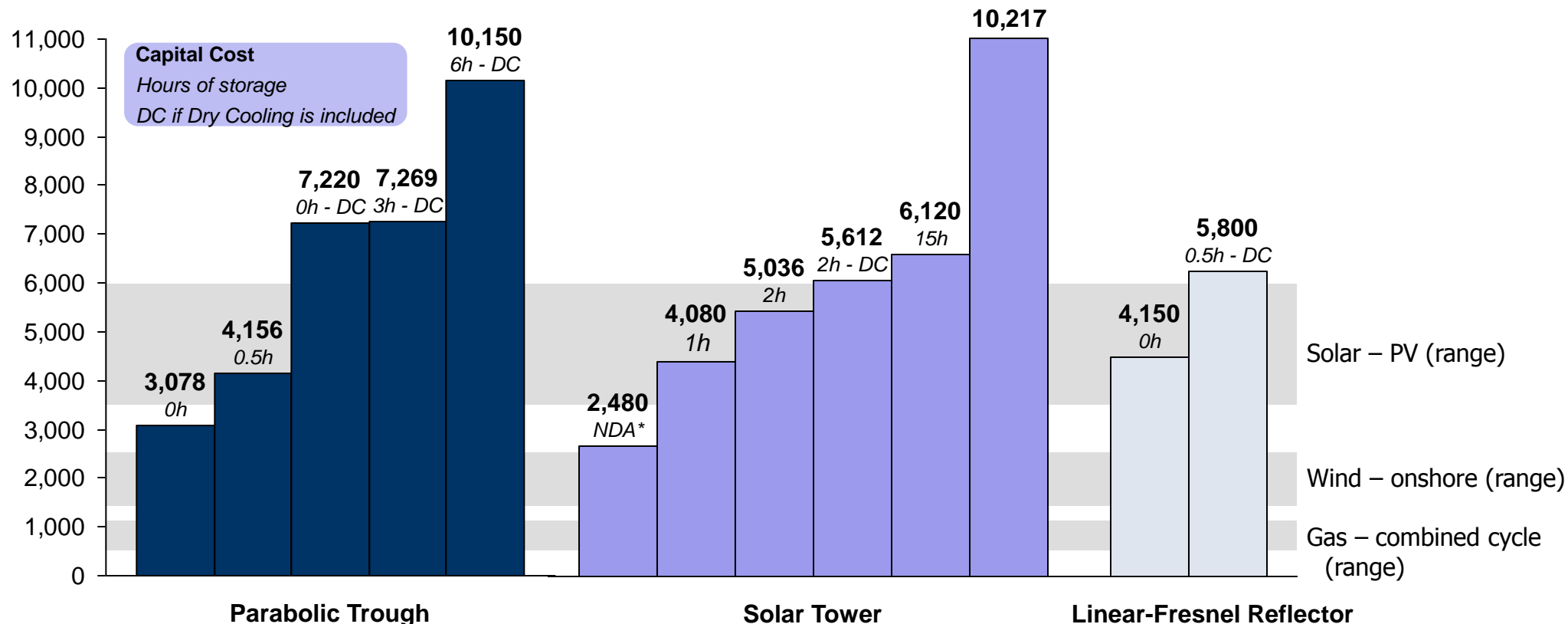

Note: Differences between capital costs can be explained by capacity factor, location, size and maturity, some plants being 'first-of-a-kind'. Data have been gathered from NREL and BNEF databases based on the total plant value divided by Installed Capacity.
 NDA: No Data Available for storage. It is believed to include molten salt storage but duration is not communicated. The 2,480 figures correspond to Supcon Solar plant under construction in China and planned for 2014 with ~800 million Yuan for 50 MW with the first phase of 10 MW commissioned in early 2013.

Source: SBC Energy Institute Analysis based on NREL SolarPaces (http://www.nrel.gov/csp/solarpaces/power_tower.cfm) and BNEF database; IEA (2012) "Energy Technology Perspective" for gas, wind and solar PV ranges

Capital costs are dominated by solar fields equipment and labour for the plant construction

CAPITAL COSTS BREAKDOWN FOR A TROUGH PLANT WITH THERMAL STORAGE

% of total capital cost

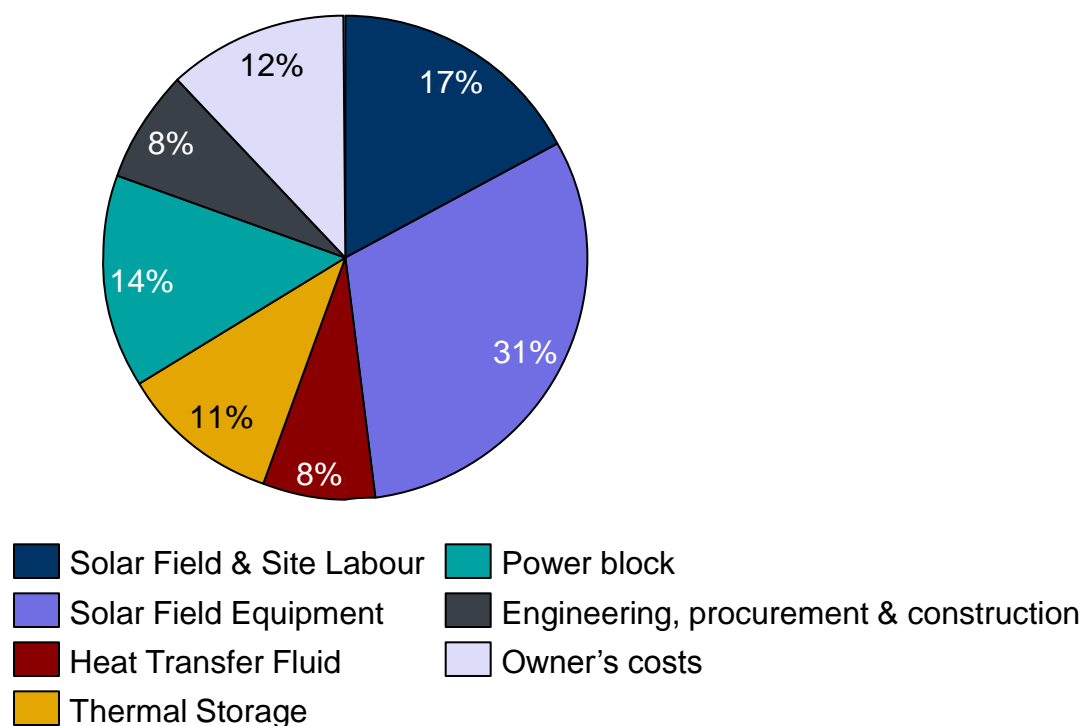

- Cost components** - Solar field accounts for the largest share of the investment cost of CSP, driven by mirrors, receivers and steel construction. Salt, storage tanks and heat exchangers are the main components of storage cost. The heat transfer fluid accounts also for a significant share of the initial capital cost.
- Solar Tower** – In the future, the capital cost of solar tower plants is expected to be lower than that of parabolic trough systems. The higher efficiency of solar towers means a smaller collector area (fewer heliostats) is required. Also, thermal storage costs are lower: according to IRENA, the absolute cost of nine hours of storage at a solar tower plant would be half the cost of the same period of storage at a parabolic trough plant.
- Labour cost** - Labour costs account for a significant share of the initial investment, with a 50 MW plant requiring a workforce of 500 people for 24 months. This could be lowered if CSP were to be developed in emerging countries.

Note: Capital costs are for a 50 MW parabolic trough with 7.5 hours of storage on the model of the Andasol plant in Spain.
 Source: IRENA (2012), "Renewable Energy Technologies: cost analysis series. Concentrating Solar Power"

Although fuel costs are low, Operation & Maintenance (O&M) costs at CSP plants are still significant, at around 30 USD/MWh

OPERATION & MAINTENANCE COSTS USD / kWh

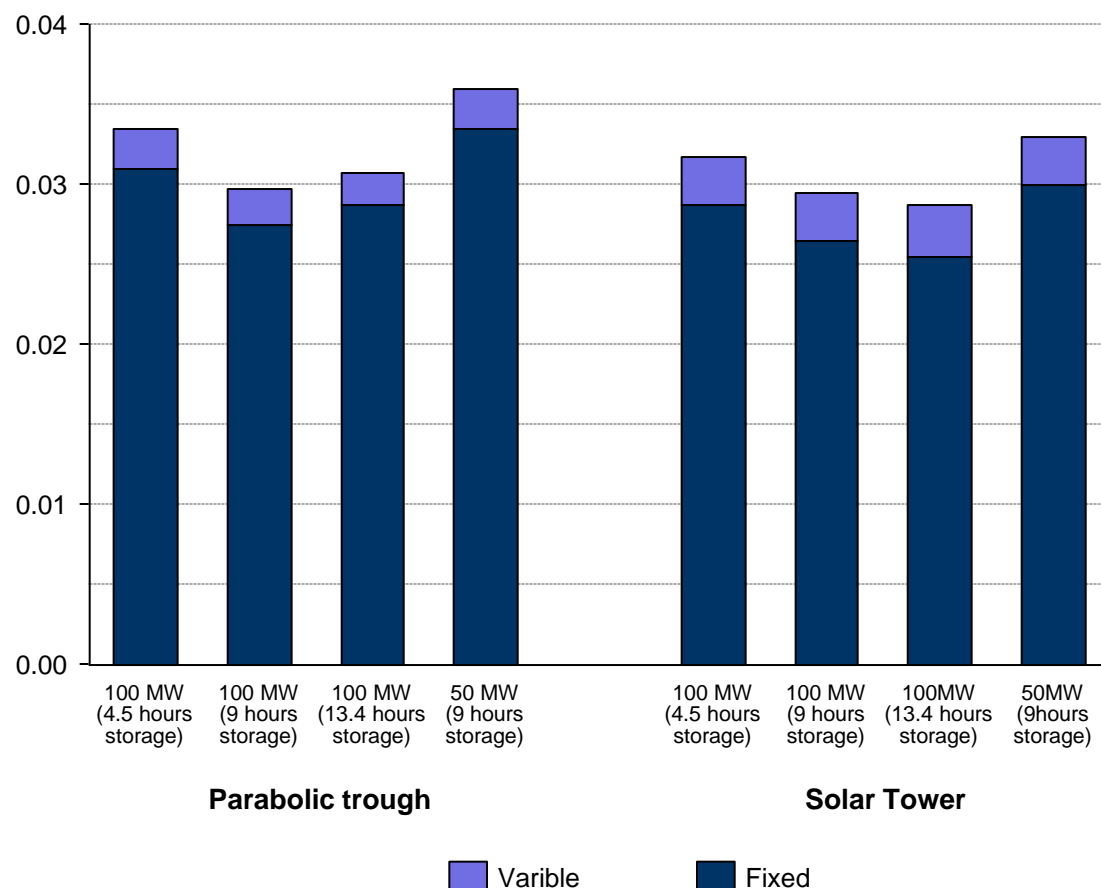

- Components** - CSP is characterized by the absence of fuel costs yet has significant operation & maintenance (O&M) costs. The main components are replacing mirrors & receivers due to glass breakage, cleaning the mirrors and insuring the plant.
- Fixed vs. Variable** - Most O&M costs are fixed (usually around 90% of them). Variable costs mainly consist of miscellaneous consumables. Typical fixed costs are 70 USD/kW/y for Parabolic Trough and 65 USD/kW/y for Solar Tower, while variable costs are around 0.003 USD/kWh.
- Labour costs** – Labour costs account for 45% in the US and only 23% in South Africa. O&M breakdown will therefore be transformed when CSP is deployed in emerging countries, having so far been deployed in Spain and the US.

Note: This analysis does not cover hybridized CSP Plants.

Source: IRENA (2012), "Renewable Energy Technologies: cost analysis series. Concentrating Solar Power"

Current levelized cost of electricity from CSP ranges from 140 to 360 USD/MWh, depending on location, technology, thermal storage size & competition

ESTIMATED LCOE FOR EXISTING AND PROPOSED CSP PLANTS USD / MWh

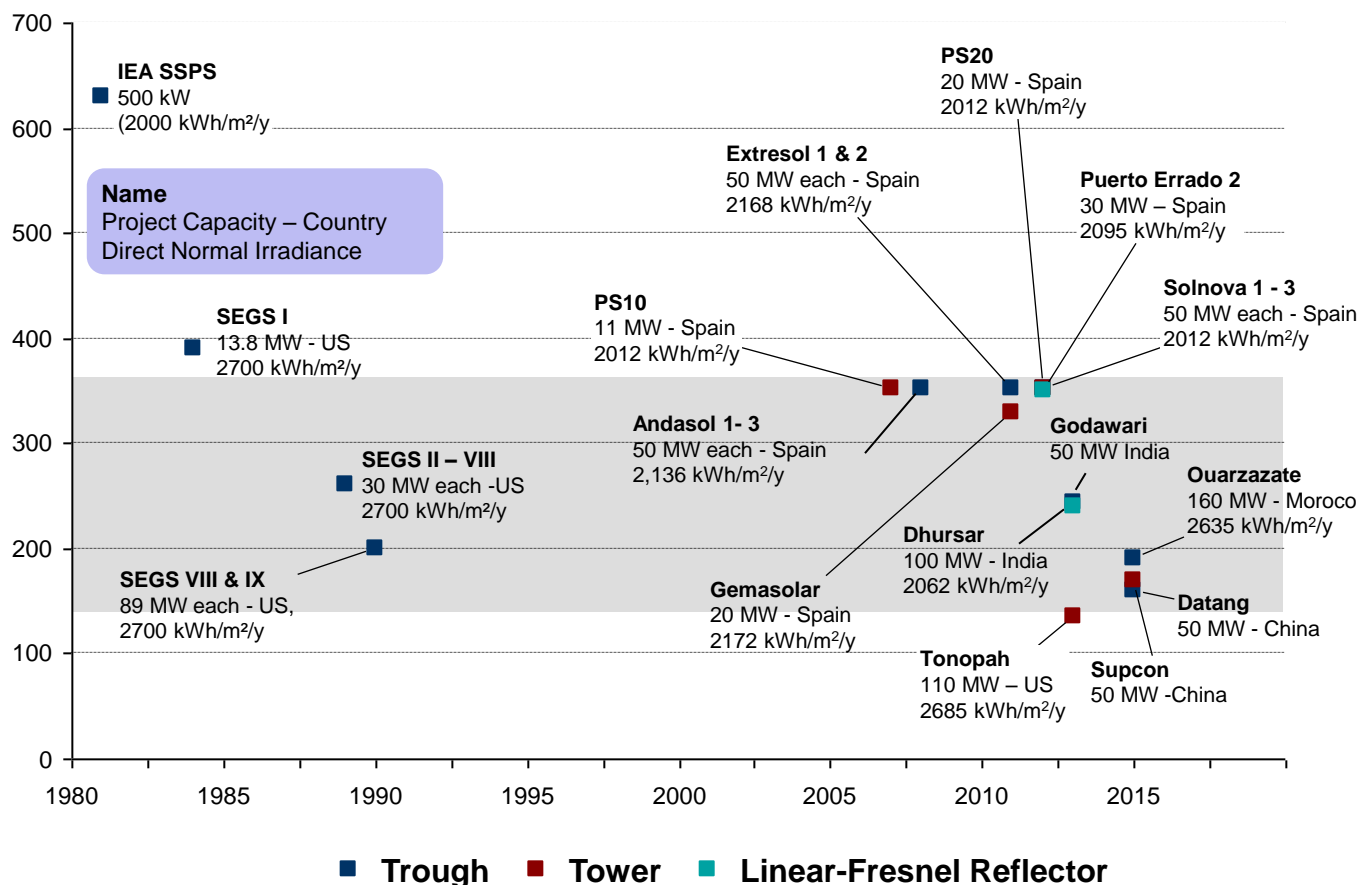

- Current levelized cost of electricity from CSP varies widely depending on project, concentrator technology and solar resource:
 - Solar tower LCOE is estimated to range from 160 and 270 USD/MWh;
 - Parabolic trough LCOE is estimated to range from 140 and 300 USD/MWh.
- The cost is highly dependent on the available sunlight and on storage, which dictate the capacity factor.

Note: LCOE for Levelized Cost of Electricity.

Source: SBC Energy Institute Analysis based on IRENA (2012), "Renewable Energy Technologies: cost analysis series. Concentrating Solar Power", NREL SolarPaces database (http://www.nrel.gov/csp/solarpaces/by_project.cfm) and BNEF

The LCOE of CSP plant is dominated by the initial investment

LCOE BREAKDOWN FOR A TROUGH PLANT

%

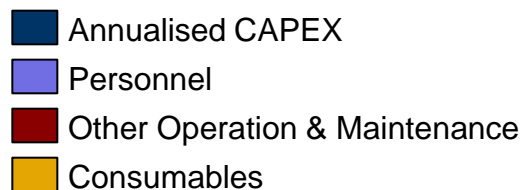
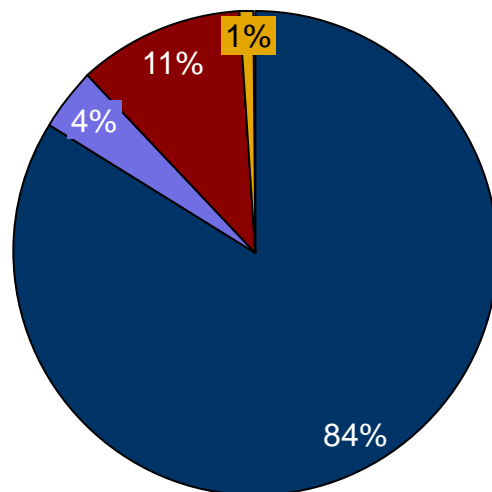

LCOE BREAKDOWN FOR A SOLAR TOWER PLANT

%

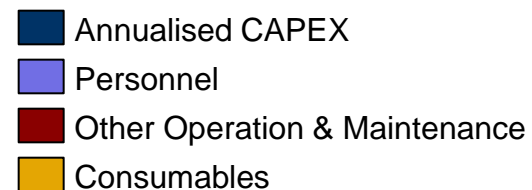
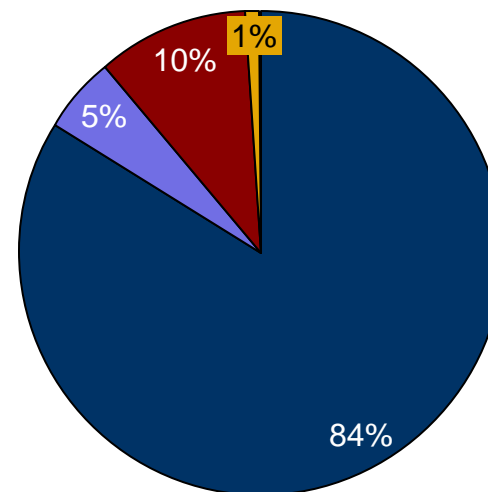

Note: LCOE for Levelized Cost of Electricity.

Source: IRENA (2012), "Renewable Energy Technologies: cost analysis series. Concentrating Solar Power"

© 2013 SBC Energy Institute. All Rights Reserved.

The quality of the solar resource has a crucial impact on the economics of CSP

IMPACT OF THE QUALITY OF THE SOLAR RESOURCE (DNI) ON THE RELATIVE LCOE % compared to a reference plant in Spain

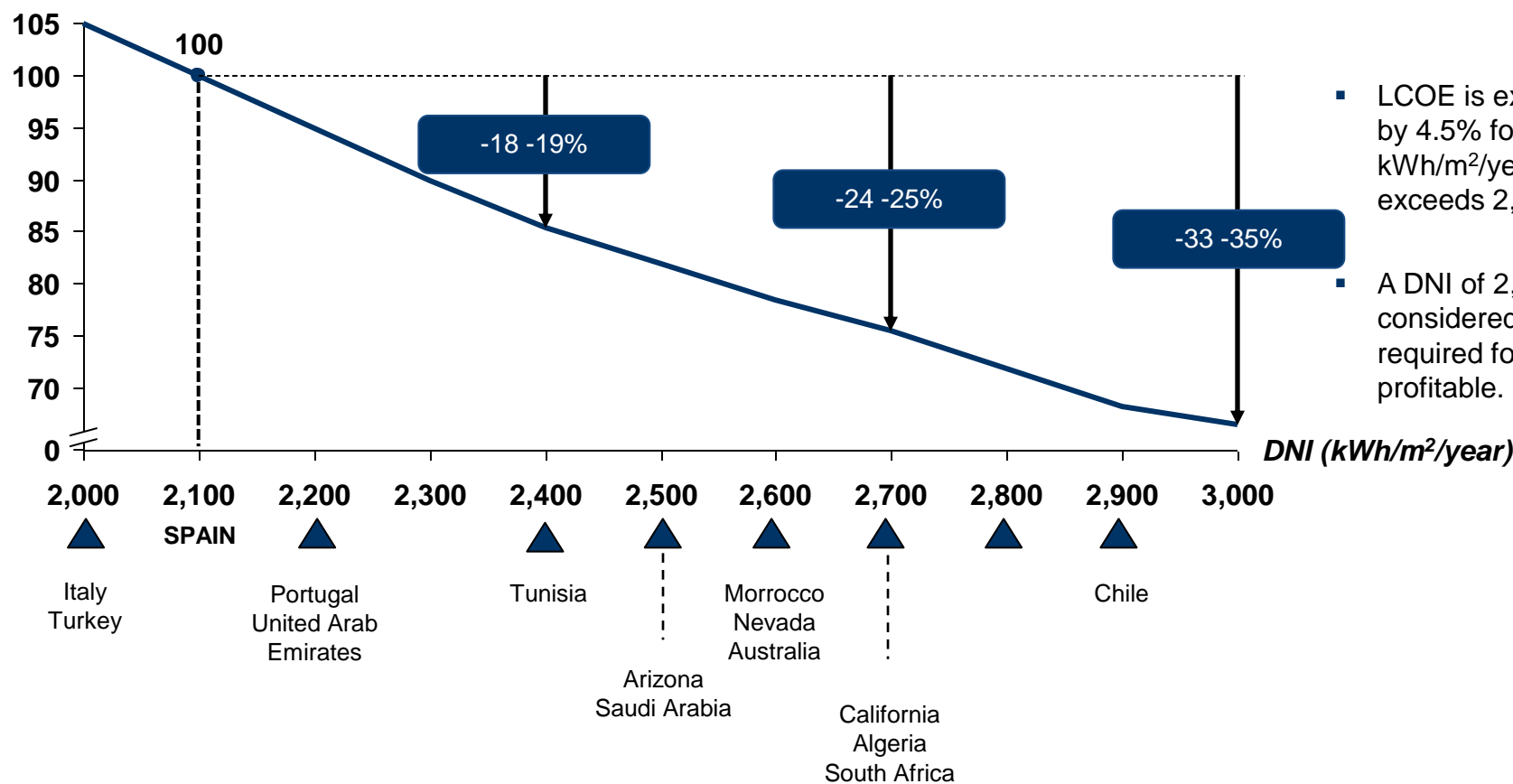

- LCOE is expected to decrease by 4.5% for every 100 kWh/m²/year that the DNI exceeds 2,100.
- A DNI of 2,000 kWh/m²/year is considered to be the minimum required for CSP to be profitable.

Note: LCOE for levelized cost of electricity and DNI for Direct Normal Irradiance.
Source: EASAC (2011), "Concentrating Solar Power"

As CSP economics are dominated by the initial investment, the discount rate has a strong impact on the LCOE

SENSITIVITY OF LCOE ON DISCOUNT RATE VARIATION

Base 100 for a 10% discount rate on three illustrative examples

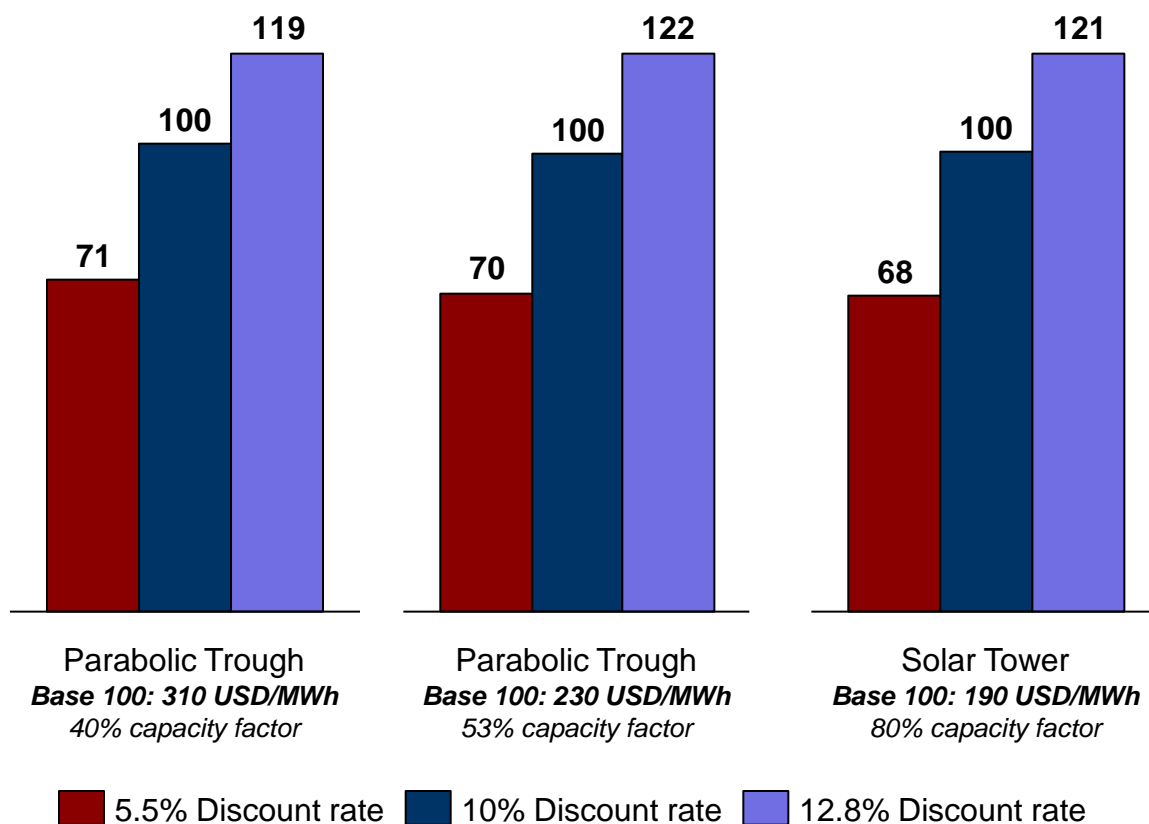

- The current debt-to-equity ratio ranges from 50% to 80%, with an average cost of debt of 5%-11% and an average construction time for projects of 24-36 months. This corresponds to a discount rate of 5%-13%.
- Given that CSP is capital driven, the debt-equity ratio and the cost of debt will strongly impact CSP economics. Lowering the risk associated with CSP and promoting favorable financial terms is an easy way to reduce CSP LCOE.

Note: Adapted from IRENA based on assumptions of same DNI for all technologies, 8000 USD/kW with 6h of storage for Parabolic Trough and 10,000 USD/kW with 12-15h storage for solar tower with 25 years of lifetime, 70 USD/kW/year of O&M costs and 0.5% insurance with fixed DNI.

Source: IRENA (2012), "Renewable Energy Technologies: cost analysis series. Concentrating Solar Power", BNEF

Despite increasing initial investment, thermal storage reduces on average the levelized cost of electricity by increasing the capacity factor

LCOE SENSITIVITY TO THERMAL STORAGE USD / MWh

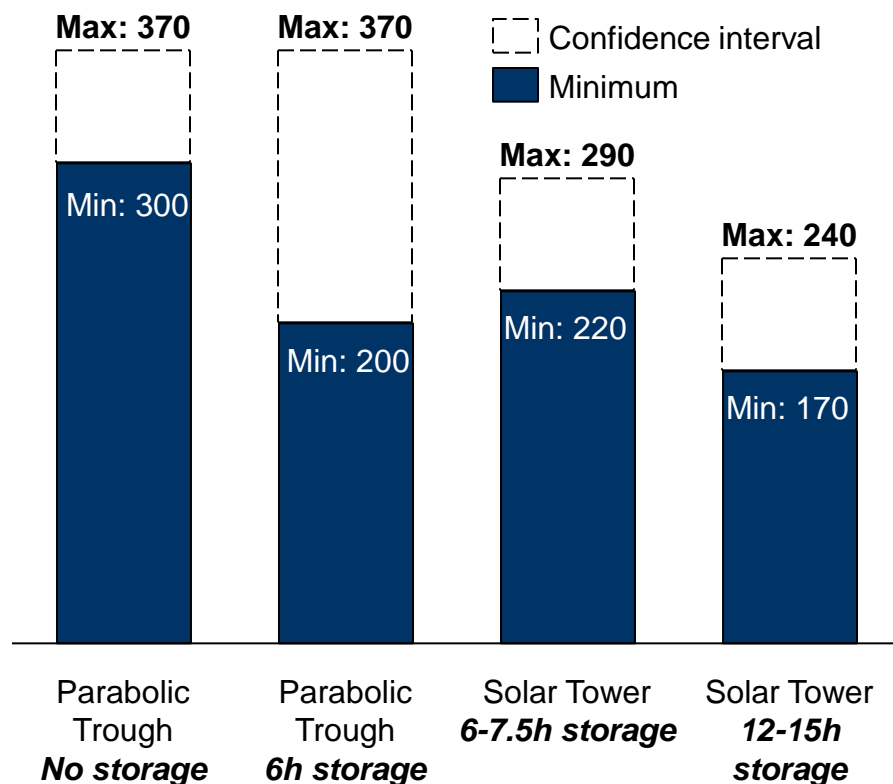

- Although thermal storage requires a higher initial investment – mainly to oversize the solar field - it enables higher capacity factor and the ability to maximize peak power price resulting in a lower generation cost.
- Solar towers have a higher operating temperature and therefore higher performance and lower storage costs. They have the potential to be almost fully dispatchable, with a capacity factor of up to 80% for 15 hours of storage.

Assumptions of the sensitivity analysis

	Capital Cost	Capacity Factor
Parabolic Trough No storage	4,600 USD/kW	20% to 25 %
Parabolic Trough 6 to 8h storage	7,100 – 9,800 USD/kW	40% to 53 %
Solar Tower 6 to 7.5h storage	6,300 – 7,500 USD/kW	40% to 45 %
Solar Tower 12 to 15h storage	9,000 – 10,500 USD/kW	65% to 80 %

Caution: LCOE figures above and capital cost assumptions on the right do not aim to provide a comprehensive range of CSP LCOE. They first and foremost illustrate the impact of thermal storage on LCOE.

Note: A 10% discount rate is applied with assumptions for 2011.

Source: IRENA (2012), "Renewable Energy Technologies: cost analysis series. Concentrating Solar Power"

Three main levers may reduce CSP's LCOE: economies of scale, decrease in component costs and higher efficiency

EXPECTED LCOE DECLINE FOR CSP PLANTS FROM 2012 TO 2025

%

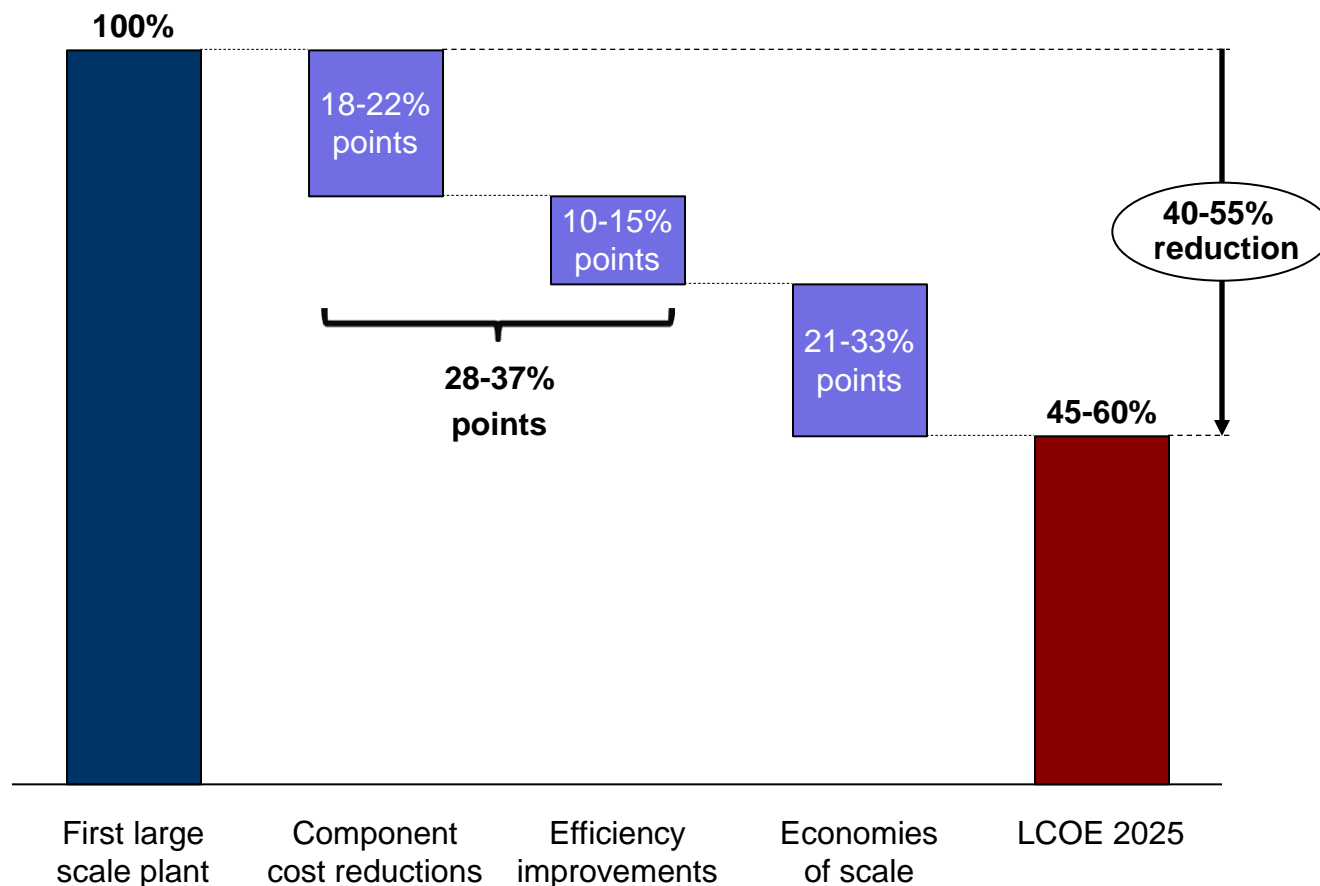

1

Economies of scale in CSP plants as plant size increases

2

Component cost decreases due to mass production & improvement in materials

3

Higher process & technology efficiency (mainly heat transfer)

If its most ambitious climate-change mitigation scenario is to be met, the IEA believes the LCOE of CSP would need to fall by more than 75%

LCOE DECREASE IN IEA 2DS SCENARIO*

USD / MWh

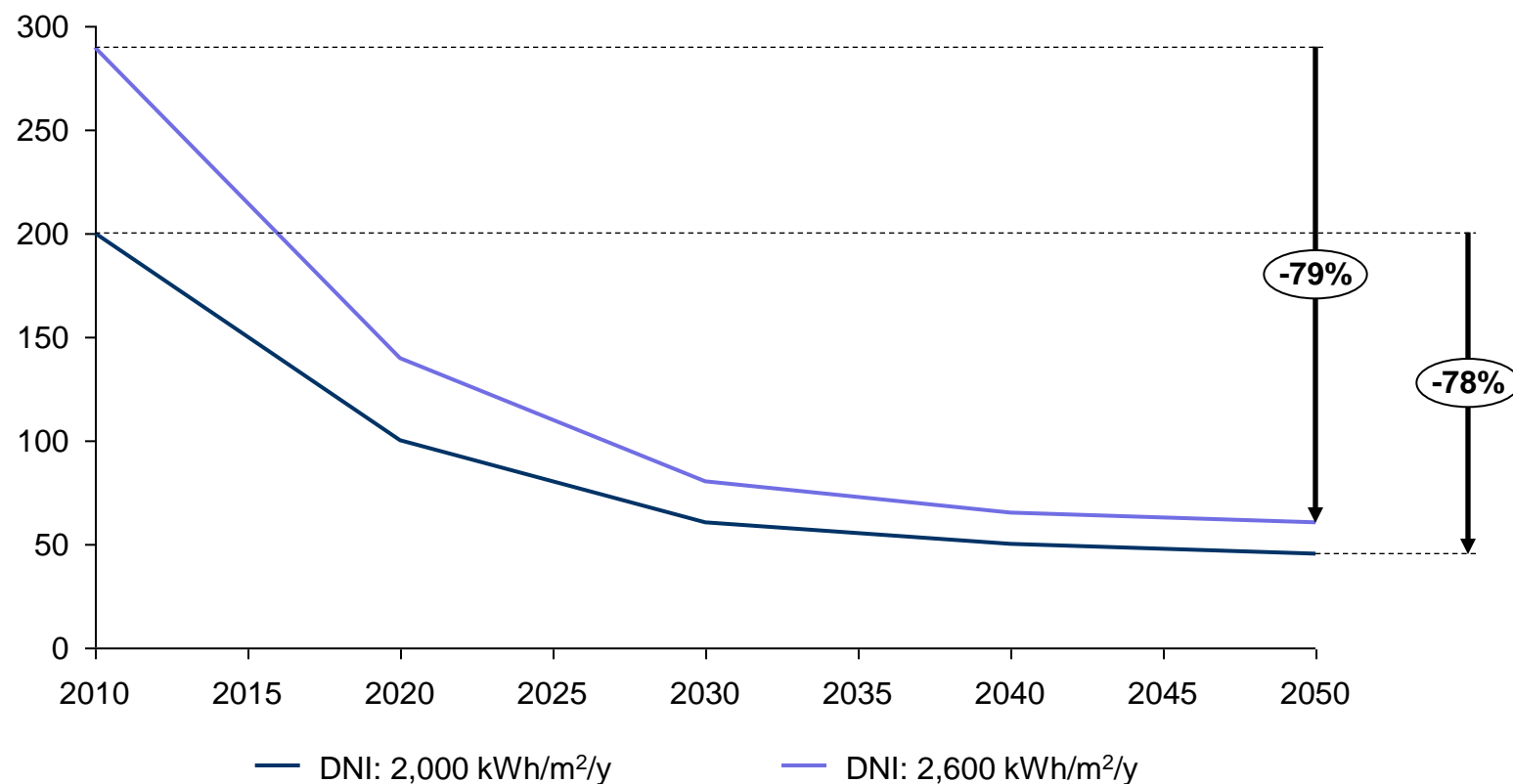

Note: * The 2DS Scenario corresponds to an energy system consistent with an emissions trajectory that recent climate-science research indicates would give an 80% chance of limiting the average global temperature increase to 2°C.
DNI stands for Direct Normal Irradiance, and is expressed in kWh/m²/year.

Source: IEA (2012), "Energy Technology Perspectives"

In view of the current technological landscape, CSP would need a very high price of CO₂ to be able to compete with alternative conventional technologies

CURRENT LCOE RANGE FOR TECHNOLOGIES WITH SEVERAL CARBON PRICE SCENARIO
USD / MWh

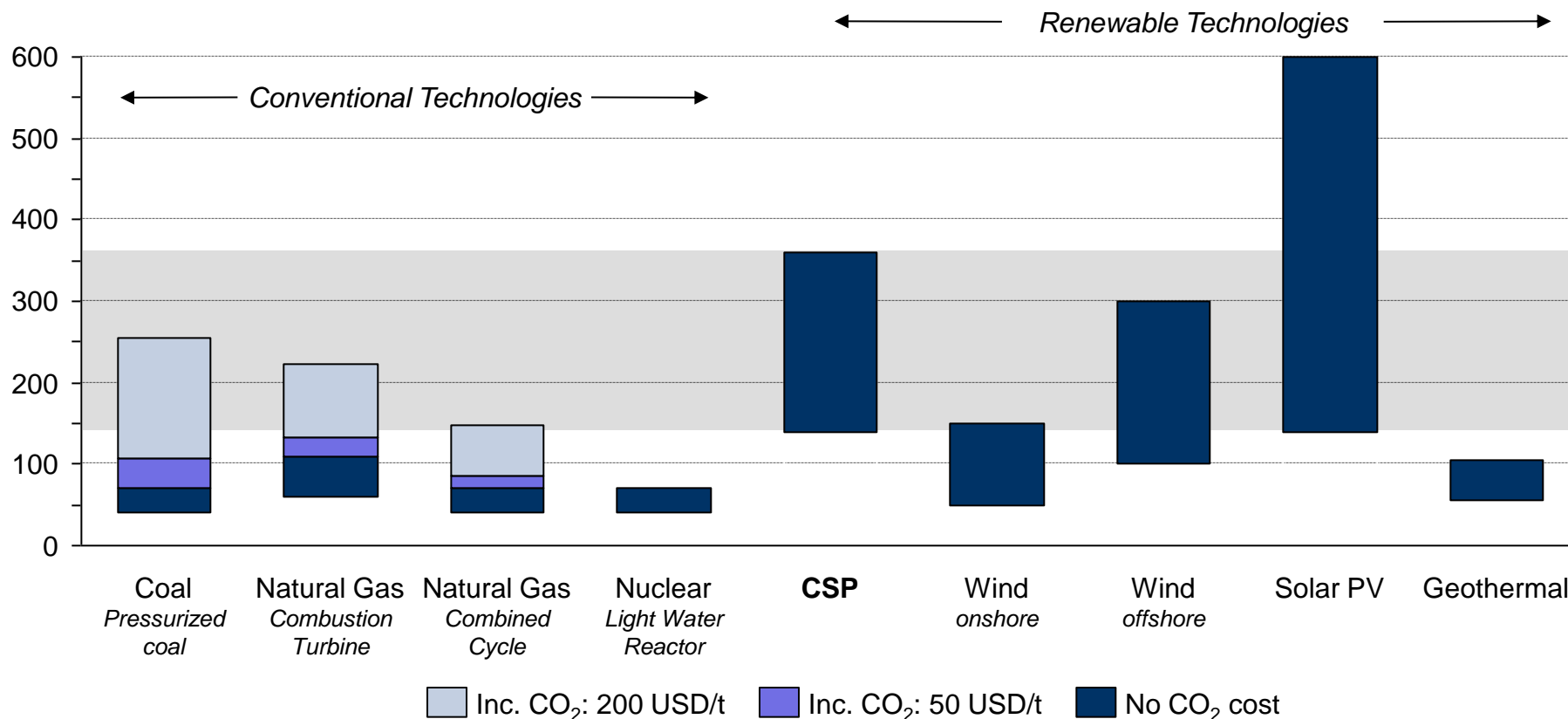

Note: Levelized Cost of Electricity (LCOE) ranges reflect differences in resources available, local conditions and choice of sub-technology. Calculations are based on a 7% discount rate and may not reflect differences in financing costs between countries. Coal carbon intensity is estimated at 740 gCO₂/kWh, Natural Gas Combustion Turbine at 400g CO₂eq./kWh and Natural Gas Combined Cycle at 310 gCO₂eq./kWh. Nuclear and renewable technologies are considered as carbon neutral.

Source: SBC Energy Institute Analysis based on IEA (2012), "Energy Technology Perspectives", IRENA cost reports series and US DoE & NREL transparent cost database

Despite increasing in 2011 as a result of new plant asset financing in the US and Spain, CSP investment is still in its infancy

TOTAL ANNUAL CSP INVESTMENT USD billion

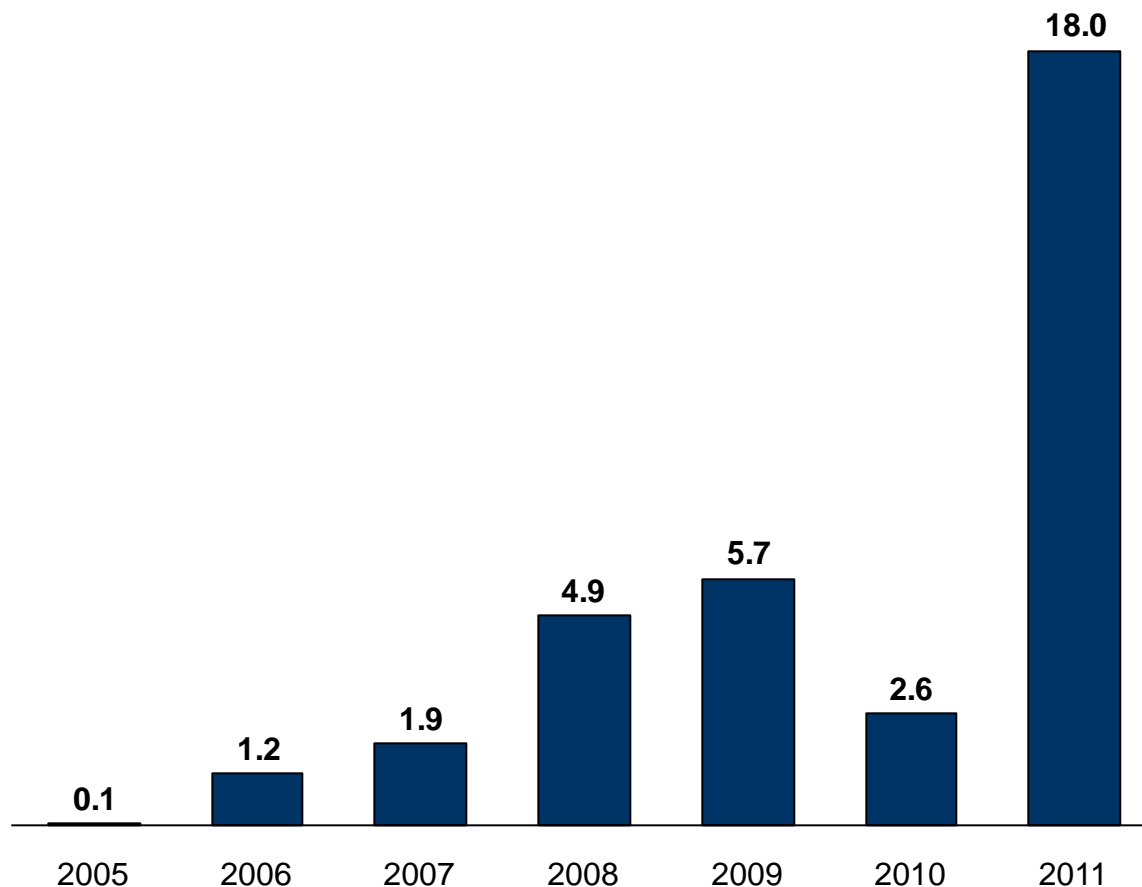

- Investment in CSP increased significantly in 2011, largely as a result of growth in asset finance for new plants in the US and Spain. On average, plants were financed 20% by equity and 80% by debt.
- Reflecting the amount of installed capacity in each technology, investment in CSP remains very limited compared with investment in Solar PV and Wind:
 - 125 USD billion for PV in 2011;
 - 84 USD billion for Wind in 2011;
 - Investment in CSP is more similar to investment in Offshore Wind, which reached 13 USD billion in 2011.

Note: Total CSP investment includes project-financing deals, equipment-manufacturing scale-up and R&D.

Source: Bloomberg New Energy Finance, extracted from database in April 18th 2012, grossed up data for Solar Thermal Technology

European and US companies dominate the CSP value chain, with a mix of traditional energy companies and pure CSP players

MAIN ACTORS ALONG THE CSP VALUE CHAIN

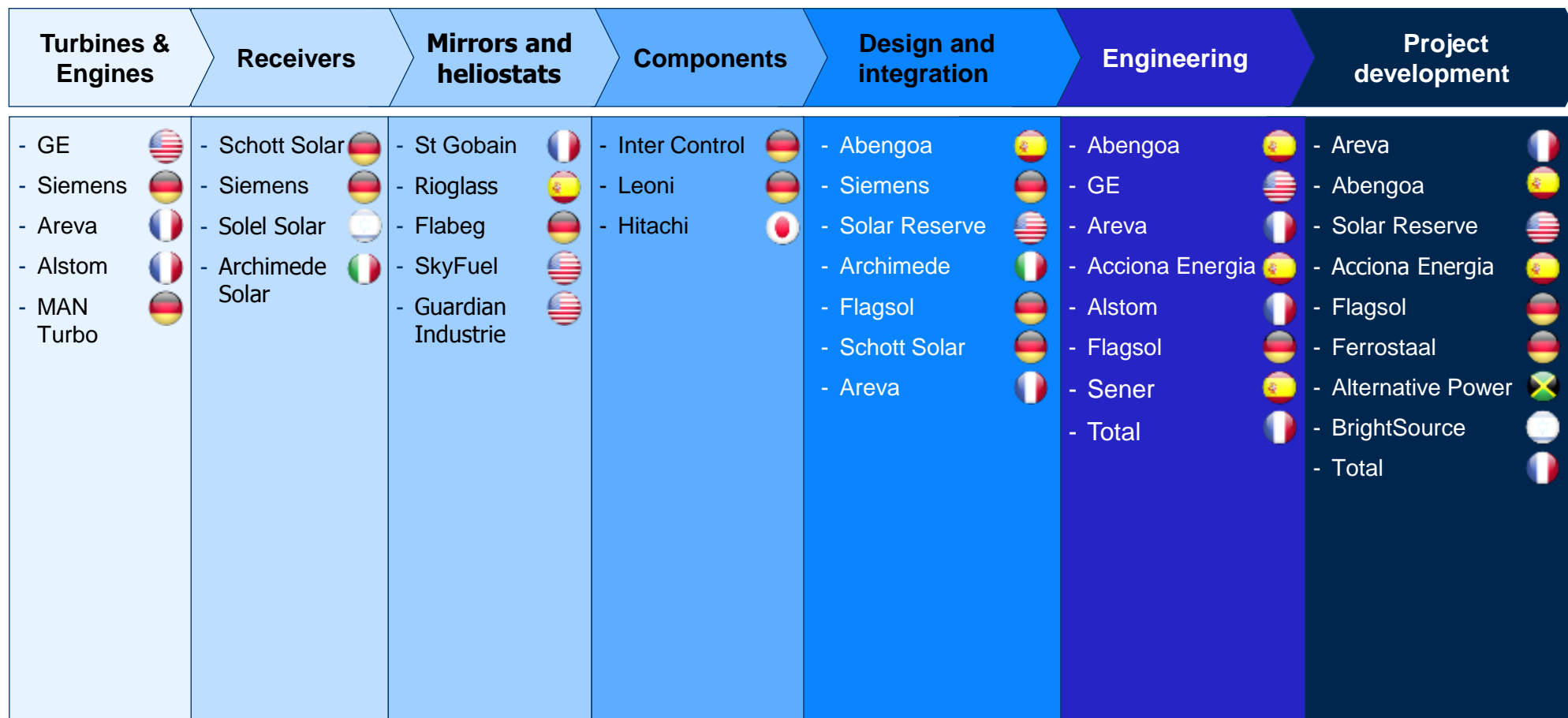

5. Environmental & Social Impacts



Greenhouse gas emissions from CSP are low and, when thermal storage is included, are not exacerbated by emissions from back-up plants

LIFECYCLE GREENHOUSE GAS (GHG) EMISSIONS

g CO₂ eq / kWh

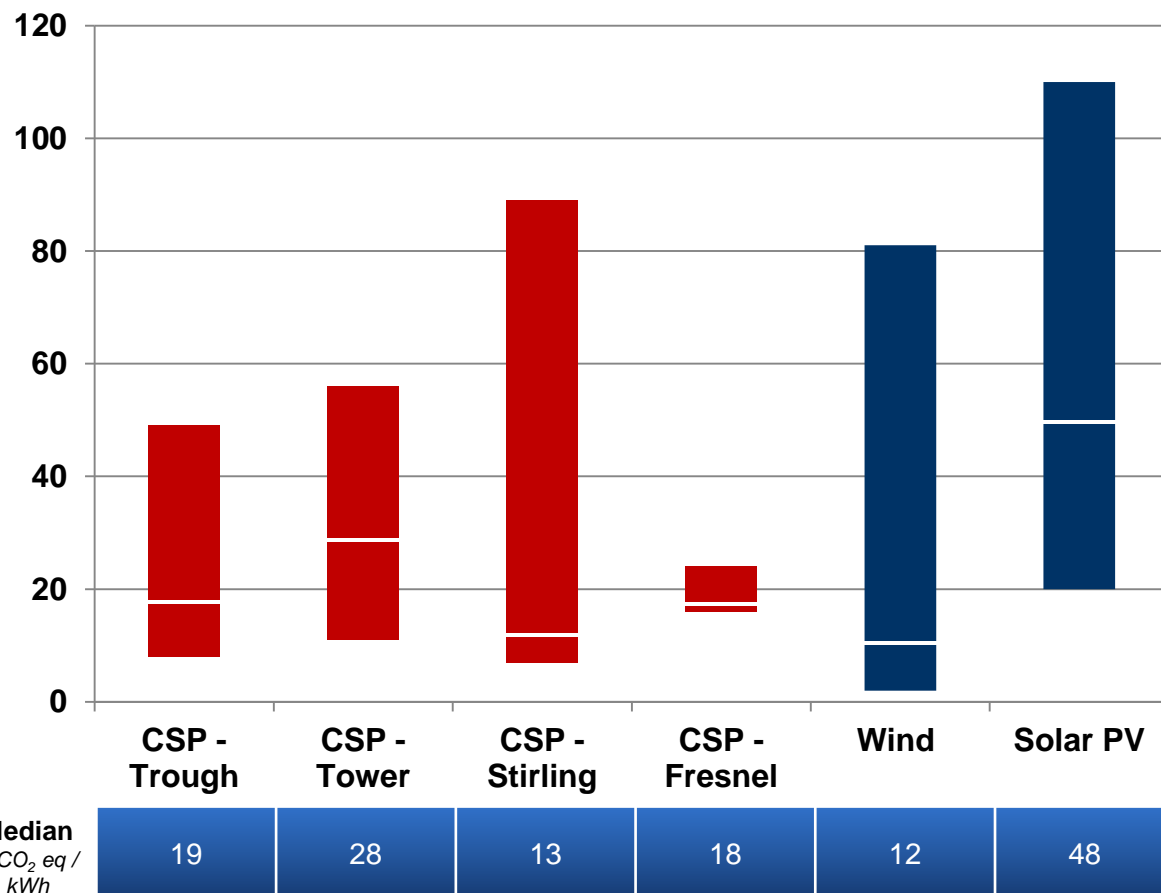

- CSP does not directly emit GHGs or other pollutants when producing electricity.
- CSP emits fewer GHGs over its lifecycle than Solar Photovoltaic (PV) and Wind. If thermal storage is included, CSP also has the advantage of not incurring emissions from the back-up plants that would otherwise be needed to balance intermittency.
- The manufacturing and disposal processes associated with CSP generate pollutants. CSP makes much more intense use of materials than other technologies. However, the main materials used are commonplace commodities such as steel, glass and concrete, for which recycling rates are high.
- Few toxic substances are used in CSP plants. The synthetic organic heat transfer fluids used in parabolic troughs present the greatest risks. They can catch fire and contaminate soils. One goal of research is to replace toxic heat transfer fluids with water or molten salts.
- Finally, CSP's land requirement averages 50 MW per km², which is intermediate between solar PV and Wind. Visual impact should be limited if CSP plants are to be built in arid, uninhabited areas.

Source: IPCC (2011), "Special report on renewable energy"

Unless dry cooling technology is used, CSP requires a significant volume of water for cooling and condensing processes

WATER CONSUMPTION OF VARIOUS PLANTS L / MWh

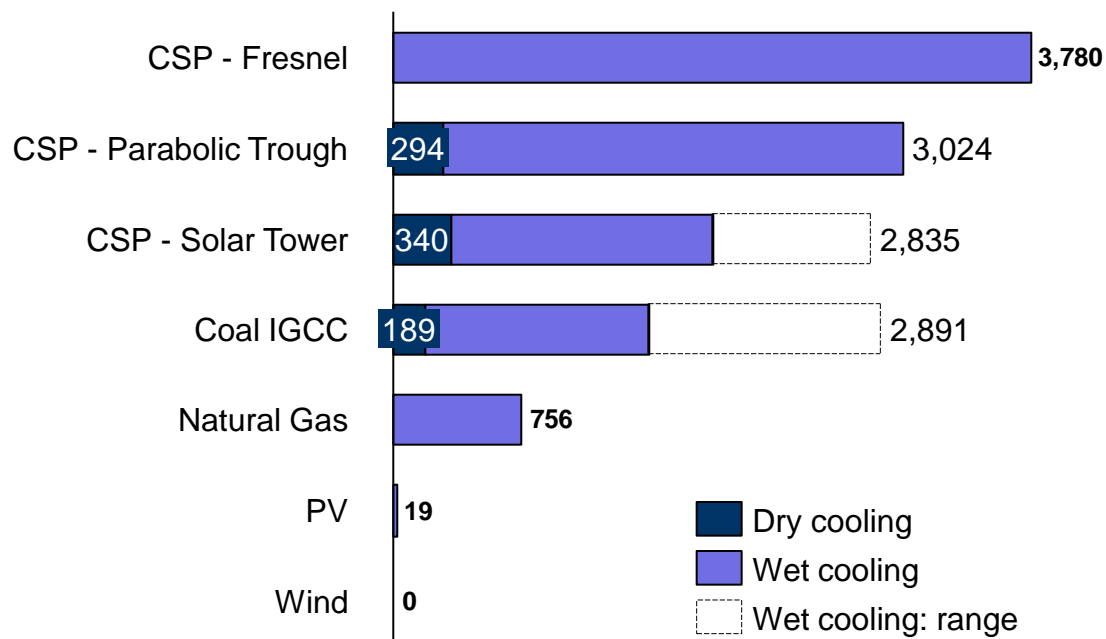

- Like fossil fuels in thermal power generation plants, CSP - except dish system - requires water for cooling & condensing processes (wet cooling process).
- The impact and accessibility of large quantities of water are important challenges in arid and semi-arid regions.
- Technologies derived from conventional power plants avoid or reduce water consumption for cooling:
 - Dry cooling technologies use air instead of water to cool the system, but require very large fans;
 - Hybrid air/water cooling technologies help reduce water consumption.
- Shams 1 (100 MW) in the UAE, commissioned in March 2013, is the largest plant operating with dry-cooling technology. It complements the three Integrated Solar Combined-Cycle plants that started up earlier in 2013 in Algeria (Hassi R'mel: 25 MW), Egypt (Kuramayyat: 20 MW), Morocco (Ain Beni Mathar: 20 MW), and Spain's Puerto Errado 2 plant (30 MW), which came online in 2012.
- Dry cooling is likely to increase the electricity generation costs (see slide 34).

Note: Water consumption refers to water that disappears or is diverted from its source, for example by evaporation, incorporation into crops or industrial processes, drinking water...It is smaller than water withdrawal, which refers to water that is essentially "sucked up" for a given use, but then returned to its source. IGCC stands for Integrated Gasification Combined Cycle. This range is representative for the US environment and may change in different conditions.

Source: CRS (2009), "Water Issues of Concentrating Solar Power (CSP) Electricity in the U.S. Southwest"

This page is intentionally left blank

6. Grid Integration



CSP's ability to incorporate energy storage is an important advantage over other renewables

STORAGE VALUE

- Like fossil steam generation plants, CSP benefits from a level of inertia that can support grid stability.
- CSP is not necessarily a variable electricity source if combined with a storage option. **Storage can allow the system to match production and peak demand when sunshine and peak times are not correlated.** In areas where peak demand does not match the sunshine, the cost of **CSP should therefore be compared with PV, Wind + storage or balancing cost.**
- Thermal storage gives CSP a crucial competitive edge because it is far more efficient and cheap than electricity storage. Thermal storage has two main objectives:
 - **Firming** the capacity of the CSP plant: Second to minute storage to smooth the variability of the solar input to provide consistent output;
 - **Time-shifting:** Hourly to daily storage to maximize electricity supply when demand and prices are high, and to minimize production when demand and prices are low.
- Growth in the use of intermittent renewables will result in a need for more flexible power systems. Energy storage, one of the most effective flexibility mechanisms, is expected to play an increasing role, but its contribution has so far been constrained by inadequate power-system regulation. Changes in regulation – such as recognizing the value of capacity reserves in ensuring high-quality, uninterrupted power supply, and enabling price arbitrage (energy storage during periods when electricity prices are low and discharge at times of peak demand) – are essential if CSP is to become more competitive.

Combining CSP with desalination technologies could be a promising option for valorizing waste heat or providing an alternative electricity storage option

CONFIGURATION OPTIONS FOR DESALINATION IN CONCENTRATING SOLAR POWER PLANTS

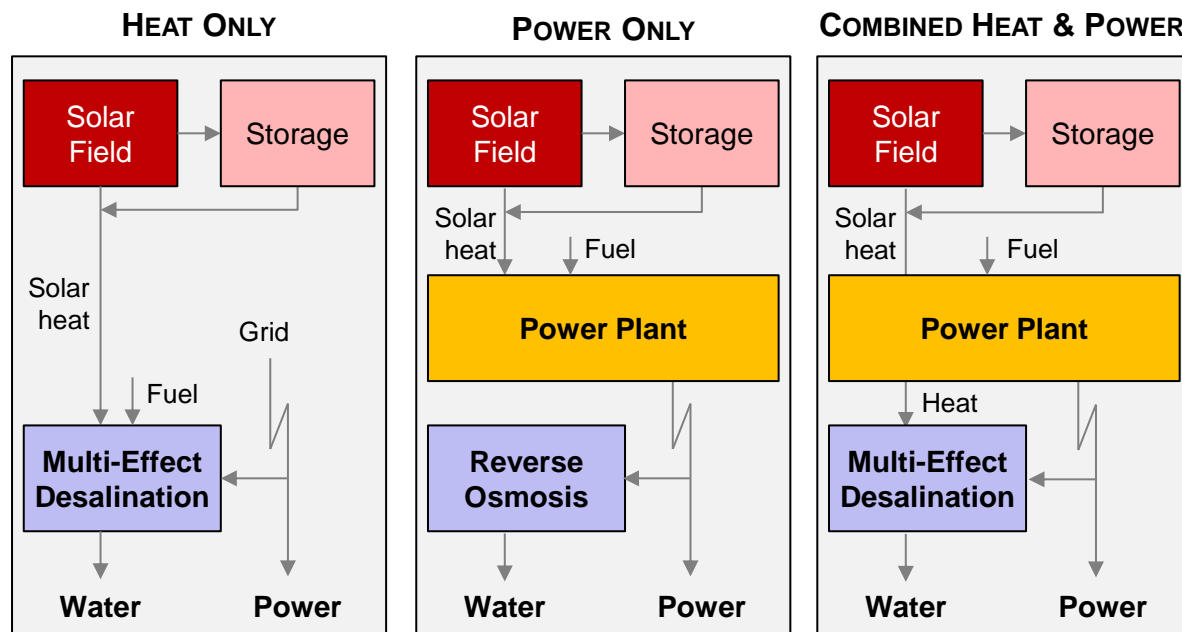

Multi-Effect Desalination (MED) and Reverse Osmosis (RO) are believed to be the most relevant desalination technologies to be used in combination with CSP. MED will be the preferred option when the feed-water salinity level is high (e.g. Arabian Gulf) as RO would in that case require water pre-treatment. In all other cases, RO - the currently dominant technology with 60% of global capacity - is likely to be less expensive.

- Desalination relies on energy-intensive* processes that can be categorized in two groups:
 - Thermal technologies* consist in distillation processes where saline water is heated and vaporized, causing fresh water to evaporate - leaving the brine behind, before being cooled down to obtain fresh water by condensation;
 - Membrane technologies* separate water by acting as a filter, allowing water molecules to pass, leaving salt molecules of the brine behind. This needs electrical voltage as driving force.
- CSP that collects solar radiation to provide high-temperature heat for power generation can be associated with both thermal and membrane technologies in a number of design options. It is promising as high direct normal irradiance area usually matches with locations that suffers from drinkable water scarcity, notably for large scale multi-purpose plants (heat, power and water).
- As water is more easily stored than electricity, water desalination combined with electricity generation could be an effective storage solution when generation exceeds demand.

Note: * In 2011, 75.2 TWh were used to produce around 24 billion m³ of water. This does not take into account the heat consumption required for thermal processes such as Multi-Stage Flash or Multi-Effect Desalination that respectively accounted for 27% and 8% of worldwide desalination capacity.

Source: DLR (2009), "Combined Solar Power and Desalination Plants: Techno-Economic Potential in Mediterranean Partner Countries"; IRENA (2012), "Water Desalination Using Renewable Energy – Technology Brief"; ABB (2012), "Solar Desalination: Important Technology Aspects"

Long-distance transmission could play a crucial role in the medium- to long-term in expanding the potential of CSP

ILLUSTRATIVE ARBITRAGE BETWEEN HVDC & HVAC TRANSMISSION LINES TECHNOLOGIES

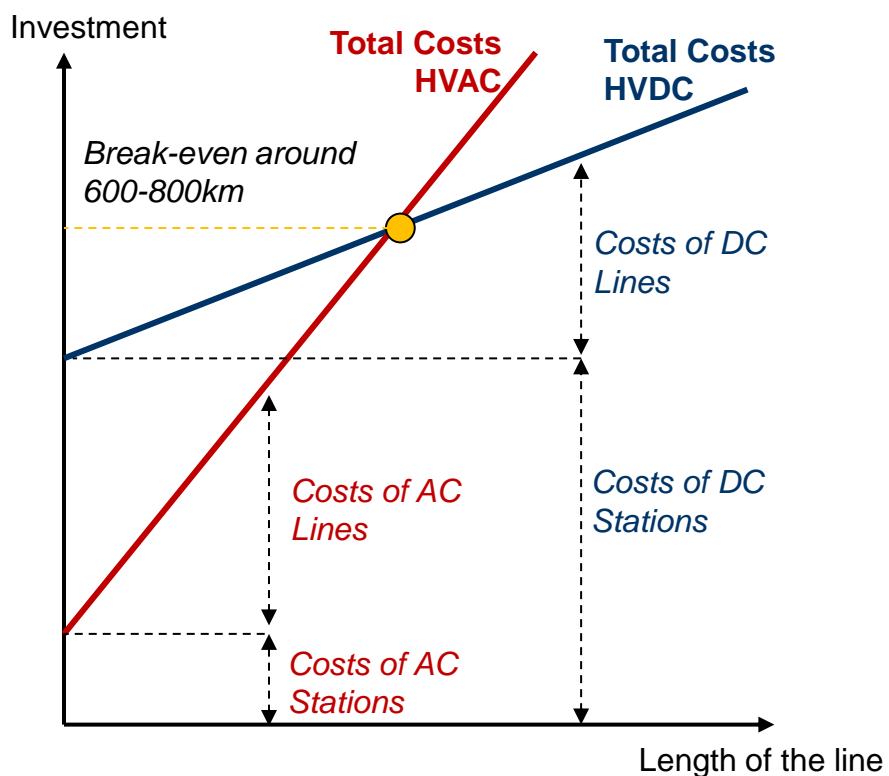

- Prevailing trends in the development of CSP indicate that, in the short to medium term, CSP electricity is likely to be consumed in the region where it is produced. In the longer term, the development of long-range electricity transmission systems could enhance the potential of CSP. These power lines may cross borders, opening up export markets for CSP producers (e.g. Northern Africa to Europe, Australia to Indonesia...), or they may be used internally to optimize electricity supply within countries (e.g. Rajasthan to Mumbai, Northern Nigeria to Lagos...).
- Experience from hydropower dams that required the construction of power lines longer than 2000 km (e.g. Xiangjiaba in China and Rio Madeira in Brazil) shows that Ultra High-Voltage Alternative Current (UHVAC) or High Voltage Direct Current (HVDC) lines can overcome the problem of long-distance transmission. However, these technologies raise costs and may face public acceptance issues. In addition, where cables cross several countries, commercial and political negotiations tend to be complex. This can result in projects taking as much as 15 years to develop. Such projects also raise sensitive questions about energy security in receiver countries.
- Over long distances, HVDC has lower capital costs than Alternative Current (AC) technology. Above a certain distance, the relatively high fixed-station costs associated with HVDC are offset by savings in conductor cables – HVDC requires fewer and thinner cables than AC. HVDC also tends to have lower distribution losses than conventional AC. HVDC can connect asynchronous grids and is virtually the only solution for long submarine cables (AC is limited to around 60 to 80 km).

Note: AC for Alternative Current, DC for Direct Current.

Source: MIT (2011), "The Future of Electric Grid"; ABB (2011), "MITEI Symposium, Grid integration of Renewables: Challenges & Technologies"

Appendix & Bibliography



Bibliography

- Abengoa Solar - Ch. Breyer and A. Gerlach (2011), *“Concentrating Solar Power A Sustainable and Dispatchable Power Option”*
- Bloomberg New Energy Finance – BNEF (2012), *online database*
- Centro de Investigaciones Energéticas, Medioambientales y Tecnológicas – CIEMAT (2007), *“Overview on Direct Steam Generation (DSG) and Experience at the Plataforma Solar de Almería (PSA)”*
- Chatham House (2009), *“Who owns our Low Carbon Future? Intellectual Property and Energy Technologies”*
- Congressional Research Service (2009), *“Water Issues of Concentrating Solar Power (CSP) Electricity in the U.S. Southwest”*
- Deutsches Zentrum für Luft und Raumfahrt – DLR (2004), *“European Concentrated Solar Thermal Road-Mapping”*
- Desertec Industrial Initiative – DII (2012), *“Desert Power 2050: Perspectives on a Sustainable Power System for EUMENA”*
- European Academies Science Advisory Council – EASAC (2011), *“Concentrating solar power: its potential contribution to a sustainable energy future”*
- European Commission Joint Research Center – EC JRC (2011), *“Capacities Map 2011 - Update on the R&D Investment in Three Selected Priority Technologies within the European Strategic Energy Technology Plan: Wind, PV and CSP”*
- European Solar Thermal Electricity Association – ESTELA (2010), *“Solar Thermal Electricity 2025 - Clean electricity on demand: attractive STE cost stabilize energy production”*
- Intergovernmental Panel on Climate Change – IPCC (2011), *“Special report on renewable energy”*
- International Energy Agency – IEA (2012), *“Energy Technology Perspectives 2012”*
- International Energy Agency – IEA (2011), *“Solar Energy Perspectives”*
- International Energy Agency – IEA (2011), *“Annual Report – Implement Agreement on Photovoltaic Power System”*
- International Energy Agency – IEA (2011), *“Harnessing Variable Renewables - A guide to balancing challenge”*
- International Energy Agency – IEA (2009), *“Concentrating Solar Power - Technology Roadmap”*
- International Renewable Energy Agency – IRENA (2012), *“Cost analysis series. Concentrating Solar Power”*
- International Renewable Energy Agency – IRENA (2012), *“Water Desalination Using Renewable Energy – Technology Brief”*
- Massachusetts Institute of Technology – MIT (2011), *“The Future of Electric Grid”*
- Natural Resources Defense Council – NRDC (2012) *“Heating Up India’s Solar Thermal Market under the National Solar Mission”*
- National Renewable Energy Laboratory – NREL (2012), SolarPaces online database (http://www.nrel.gov/csp/solarpaces/by_project.cfm)
- United Nations Environment Programme – UNEP (2012), *“Global Trends in renewable Investment 2012”*

Acronyms

- **AC:** Alternative Current
- **CAGR:** Compound Annual Growth Rate
- **CCS:** Carbon Capture & Storage
- **CHP:** Combined Heat & Power
- **CSP:** Concentrating Solar Power
- **DC:** Direct Current
- **DII:** Desertec Industrial Initiative
- **DNI:** Direct Normal Irradiance
- **DSG:** Direct Steam Generation
- **EOR:** Enhanced Oil Recovery
- **GHG:** Greenhouse Gas
- **HVAC:** High Voltage Alternative Current
- **HVDC:** High Voltage Direct Current
- **IGCC:** Integrated Gasification Combined Cycle
- **ISCC:** Integrated Solar Combined Cycle
- **LCOE:** Levelized Cost of Electricity
- **LFR:** Linear-Fresnel Reflector
- **MENA:** Middle East and North Africa
- **PC:** Pulverized Coal Power Plant
- **PCM:** Phase Change Material
- **PV:** Photovoltaic
- **UHVDC:** Ultra High Voltage Direct Current
- **W:** Watt
- **Wp:** Watt Peak

June 2013

Copyright © SBC Energy Institute

Registered as follows: Stichting SBC Energy Institute, KVK 52935221, Parkstraat 83 -89, 2514JG, 's- Gravenhage
Netherlands